

Inspiron 14 7430 2-in-1

Owner's Manual



Notes, cautions, and warnings

 **NOTE:** A NOTE indicates important information that helps you make better use of your product.

 **CAUTION:** A CAUTION indicates either potential damage to hardware or loss of data and tells you how to avoid the problem.

 **WARNING:** A WARNING indicates a potential for property damage, personal injury, or death.

Chapter 1: Views of Inspiron 14 7430 2-in-1.....	6
Right.....	6
Left.....	6
Top.....	7
Front.....	9
Bottom.....	10
Modes.....	10
Chapter 2: Set up your Inspiron 14 7430 2-in-1.....	12
Chapter 3: Specifications of Inspiron 14 7430 2-in-1.....	14
Dimensions and weight.....	14
Processor.....	14
Chipset.....	15
Operating system.....	15
Memory.....	15
External ports.....	15
Internal slots.....	16
Wireless module.....	16
Audio.....	17
Storage.....	17
Media-card reader.....	18
Keyboard.....	18
Keyboard function keys.....	18
Camera.....	19
Touchpad.....	20
Power adapter.....	20
Battery.....	21
Display.....	22
Fingerprint reader (optional).....	22
GPU—Integrated.....	23
External display support.....	23
Operating and storage environment.....	23
Dell Support policy.....	24
ComfortView.....	24
Chapter 4: Working inside your computer.....	25
Safety instructions.....	25
Before working inside your computer.....	25
Safety precautions.....	26
Electrostatic discharge—ESD protection.....	26
ESD field service kit	27
Transporting sensitive components.....	28
After working inside your computer.....	28

BitLocker.....	28
Recommended tools.....	28
Screw list.....	29
Major components of Inspiron 14 7430 2-in-1.....	30
Chapter 5: Removing and installing Customer Replaceable Units (CRUs).....	32
Base cover.....	32
Removing the base cover.....	32
Installing the base cover.....	34
Solid-state drive.....	36
Removing the M.2 2230 solid-state drive.....	36
Installing the M.2 2230 solid-state drive.....	37
Removing the M.2 2280 solid-state drive.....	39
Installing the M.2 2280 solid-state drive.....	39
Wireless card.....	40
Removing the wireless card.....	40
Installing the wireless card.....	41
Fan.....	43
Removing the fan.....	43
Installing the fan.....	43
Chapter 6: Removing and installing Field Replaceable Units (FRUs).....	45
Battery.....	45
Lithium-ion battery precautions.....	45
Removing the battery.....	45
Installing the battery.....	46
Coin-cell battery.....	47
Removing the coin-cell battery.....	47
Installing the coin-cell battery.....	48
Heat sink.....	49
Removing the heat sink.....	49
Installing the heat sink.....	50
I/O board.....	51
Removing the I/O board.....	51
Installing the I/O board.....	52
Power-button.....	53
Removing the power-button.....	53
Installing the power-button	54
Removing the power-button with fingerprint reader	55
Installing the power-button with fingerprint reader	56
Touchpad.....	57
Removing the touchpad.....	57
Installing the touchpad.....	58
Speakers.....	60
Removing the speakers.....	60
Installing the speakers.....	61
Display assembly.....	63
Removing the display assembly.....	63
Installing the display assembly.....	64

System board.....	66
Removing the system board.....	66
Installing the system board.....	69
Palm-rest and keyboard assembly.....	72
Removing the palm-rest and keyboard assembly.....	72
Installing the palm-rest and keyboard assembly.....	73
Chapter 7: Software.....	75
Operating system.....	75
Drivers and downloads.....	75
Chapter 8: BIOS setup.....	76
Entering BIOS setup program.....	76
Navigation keys.....	76
One time boot menu.....	76
System setup options.....	77
Updating the BIOS.....	81
Updating the BIOS in Windows.....	81
Updating the BIOS using the USB drive in Windows.....	81
Updating the BIOS from the F12 One-Time boot menu.....	81
System and setup password.....	82
Assigning a system setup password.....	82
Deleting or changing an existing system setup password.....	83
Clearing CMOS settings.....	83
Clearing BIOS (System Setup) and System passwords.....	84
Chapter 9: Troubleshooting.....	85
Handling swollen Lithium-ion batteries.....	85
Locate the Service Tag or Express Service Code of your Dell computer	85
Dell SupportAssist Pre-boot System Performance Check diagnostics.....	86
Running the SupportAssist Pre-Boot System Performance Check.....	86
Built-in self-test (BIST).....	86
M-BIST.....	86
LCD Power rail test (L-BIST).....	87
LCD Built-in Self Test (BIST).....	87
System-diagnostic lights.....	88
Recovering the operating system.....	90
Real-Time Clock (RTC Reset).....	90
Backup media and recovery options.....	90
WiFi power cycle.....	91
Drain residual flea power (perform hard reset).....	91
Chapter 10: Getting help and contacting Dell.....	92

Views of Inspiron 14 7430 2-in-1

Right



1. SD-card slot

Reads from and writes to the SD card. The computer supports the following card types:

- Secure Digital (SD)
- Secure Digital High Capacity (SDHC)
- Secure Digital Extended Capacity (SDXC)

2. USB 3.2 Gen 1 port

Connect devices such as external storage devices and printers. Provides data transfer speeds up to 5 Gbps.

3. Universal audio jack

Connect headphones or a headset (headphone and microphone combo).

Left



1. HDMI 1.4 port

Connect to a TV, external display or another HDMI-in enabled device. Provides video and audio output.

2. Thunderbolt 4 port with Power Delivery (primary power)

Supports DisplayPort 1.4 and Thunderbolt 4 and also enables you to connect to an external display using a display adapter. Provides data transfer rates of up to 40 Gbps.

NOTE: Connect your USB Type-C power adapter to this port to charge your computer.

NOTE: A USB Type-C to DisplayPort adapter (sold separately) is required to connect a DisplayPort device.

NOTE: Thunderbolt 4 supports two 4K displays or one 8K display.

NOTE: Displays connected through the Thunderbolt port get graphics acceleration only from the integrated graphics and not through your discrete graphics card. For the best gaming performance, connect your display directly through your computer's HDMI port or DisplayPort port.

3. Thunderbolt 4 port with Power Delivery

Supports DisplayPort 1.4 and Thunderbolt 4 and also enables you to connect to an external display using a display adapter. Provides data transfer rates of up to 40 Gbps.

NOTE: Connect your USB Type-C power adapter to this port to charge your computer.

NOTE: A USB Type-C to DisplayPort adapter (sold separately) is required to connect a DisplayPort device.

NOTE: Thunderbolt 4 supports two 4K displays or one 8K display.

NOTE: Displays connected through the Thunderbolt port get graphics acceleration only from the integrated graphics and not through your discrete graphics card. For the best gaming performance, connect your display directly through your computer's HDMI port or DisplayPort port.

4. Power and battery-status light

Indicates the power state and battery state of the computer.

Solid white—Power adapter is connected and the battery is charging.

Solid amber—Battery charge is low or critical.

Off—Battery is fully charged.

NOTE: On certain computer models, the power and battery-status light are also used for diagnostics. For more information, see the *Troubleshooting* section in your computer's *Service Manual*.

Top

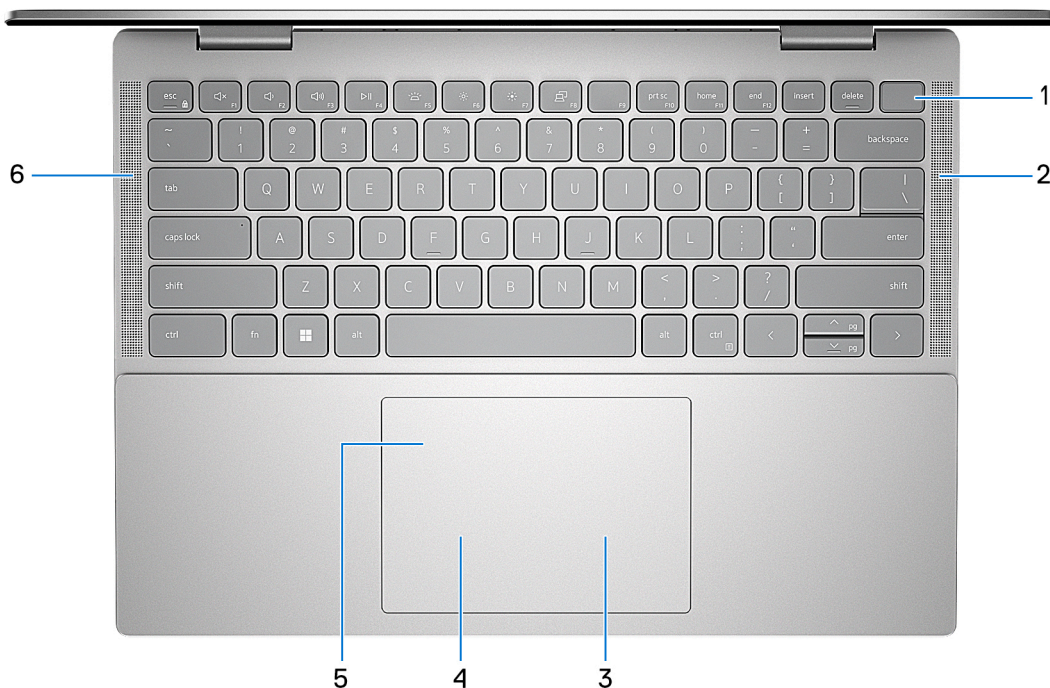

1. Power button with optional fingerprint reader

Press to turn on the computer if it is turned off, in sleep state, or in hibernate state.

When the computer is turned on, press the power button to put the computer into sleep state; press and hold the power button for four seconds to force shut-down the computer.

If the power button has a fingerprint reader, place your finger on the power button to log in.

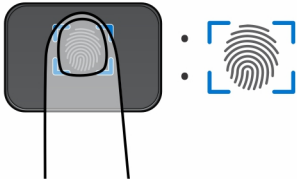

NOTE: The highlighted area indicates the actual active fingerprint reader area and the image is for illustration purposes only.

NOTE: You can customize power-button behavior in Windows. For more information, see *Me and My Dell* at www.dell.com/support/manuals.

2. Right speaker

Provides audio output.

3. Right-click area

Press to right-click.

4. Left-click area

Press to left-click.

5. Precision touchpad

Move your finger on the touchpad to move the mouse pointer. Tap to left-click and two fingers tap to right-click.

6. Left speaker

Provides audio output.

Front



1. Left microphone

Provides digital sound input for audio recording and voice calls.

2. Privacy shutter

Slide the privacy shutter to cover the camera lens and protect your privacy when the camera is not in use.

3. Camera

Enables you to video chat, capture photos, and record videos.

4. Camera-status light

Turns on when the camera is in use.

5. Right microphone

Provides digital sound input for audio recording and voice calls.

Bottom

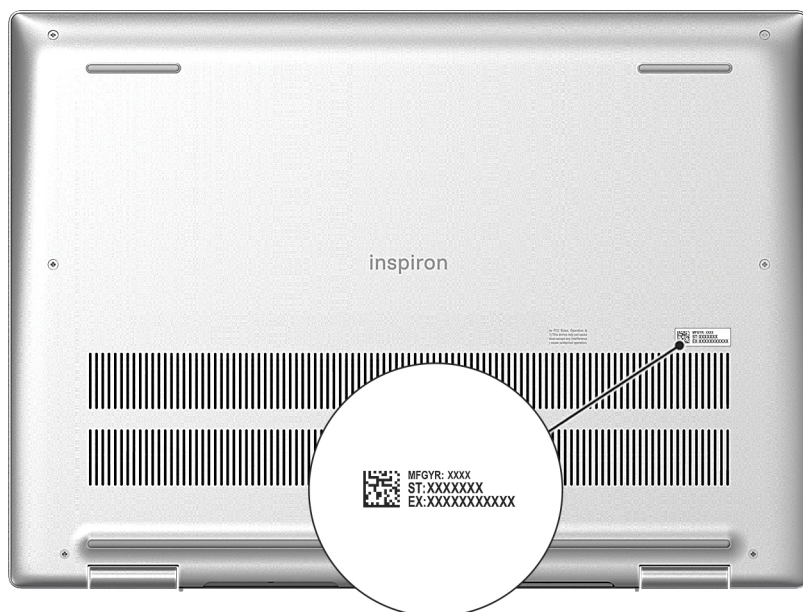

1. Service Tag label

The Service Tag is a unique alphanumeric identifier that enables Dell service technicians to identify the hardware components in your computer and access warranty information.

Modes

The following modes are applicable for your 2-in-1 computers.

Notebook



Tablet



Stand



Tent



Set up your Inspiron 14 7430 2-in-1

About this task

NOTE: The images in this document may differ from your computer depending on the configuration you ordered.

Steps

1. Connect the power adapter and press the power button.



NOTE: To conserve battery power, the battery might enter power-saving mode. Connect the power adapter and press the power button to turn on the computer.

2. Finish Windows setup.

Follow the on-screen instructions to complete the setup. When setting up, Dell recommends that you:

- Connect to a network for Windows updates.
 - NOTE:** If connecting to a secured wireless network, enter the password for the wireless network access when prompted.
- If connected to the Internet, sign in with or create a Microsoft account. If not connected to the Internet, create an offline account.
- On the **Support and Protection** screen, enter your contact details.

3. Locate and use Dell apps from the Windows Start menu—Recommended.

Table 1. Locate Dell apps in Windows in S-mode

Resources	Description
	<p>Dell Product Registration Register your computer with Dell.</p>

Table 1. Locate Dell apps in Windows in S-mode (continued)









Resources	Description
	<p>Dell Help & Support</p> <p>Access help and support for your computer.</p>
	<p>SupportAssist</p> <p>SupportAssist proactively and predictively identifies hardware and software issues on your computer and automates the engagement process with Dell Technical support. It addresses performance and stabilization issues, prevents security threats, monitors, and detects hardware failures. For more information, see <i>SupportAssist for Home PCs User's Guide</i> at www.dell.com/serviceabilitytools. Click SupportAssist and then, click SupportAssist for Home PCs.</p> <p> NOTE: In SupportAssist, click the warranty expiry date to renew or upgrade your warranty.</p>

Table 2. Locate Dell apps in Windows

Resources	Description
	<p>My Dell</p> <p>Centralized location for key Dell applications, help articles, and other important information about your computer. It also notifies you about the warranty status, recommended accessories, and software updates if available.</p>
	<p>Dell Update</p> <p>Updates your computer with critical fixes and latest device drivers as they become available. For more information on using Dell Update, search in the Knowledge Base Resource at www.dell.com/support.</p>
	<p>Dell Digital Delivery</p> <p>Download software applications, which are purchased but not preinstalled on your computer. For more information on using Dell Digital Delivery, search in the Knowledge Base Resource at www.dell.com/support.</p>
	<p>SupportAssist</p> <p>SupportAssist proactively and predictively identifies hardware and software issues on your computer and automates the engagement process with Dell Technical support. It addresses performance and stabilization issues, prevents security threats, monitors, and detects hardware failures. For more information, see <i>SupportAssist for Home PCs User's Guide</i> at www.dell.com/serviceabilitytools. Click SupportAssist and then, click SupportAssist for Home PCs.</p> <p> NOTE: In SupportAssist, click the warranty expiry date to renew or upgrade your warranty.</p>

Specifications of Inspiron 14 7430 2-in-1

Dimensions and weight

The following table lists the height, width, depth, and weight of your Inspiron 14 7430 2-in-1.

Table 3. Dimensions and weight

Description	Values
Height:	
Front height	15.54 mm (0.61 in.)
Rear height	17.47 mm (0.69 in.)
Width	314 mm (12.36 in.)
Depth	226.56 mm (8.92 in.)
Weight  NOTE: The weight of your computer depends on the configuration ordered and manufacturing variability.	<ul style="list-style-type: none"> • Minimum: 1.58 kg (3.48 lb) • Maximum: 1.62 kg (3.57 lb)

Processor

The following table lists the details of the processors supported by your Inspiron 14 7430 2-in-1.

Table 4. Processor

Description	Option one	Option two	Option three
Processor type	13 th Generation Intel Core i3-1315U	13 th Generation Intel Core i5-1335U	13 th Generation Intel Core i7-1355U
Processor wattage	15 W	15 W	15 W
Processor core count	6	10	10
Processor thread count	8	12	12
Processor speed	Up to 4.50 GHz	Up to 4.60 GHz	Up to 5 GHz
Processor cache	10 MB	12 MB	12 MB
Integrated graphics	Intel UHD Graphics	Intel Iris X ^e Graphics	Intel Iris X ^e Graphics

Chipset

The following table lists the details of the chipset supported by your Inspiron 14 7430 2-in-1.

Table 5. Chipset

Description	Values
Chipset	Integrated in the processor
Processor	13 th Generation Intel Core i3/i5/i7
DRAM bus width	64-bit
Flash EPROM	32 MB
PCIe bus	Up to Gen4

Operating system

Your Inspiron 14 7430 2-in-1 supports the following operating systems:

- Windows 11 Pro, 64-bit
- Windows 11 Pro National Education, 64-bit
- Windows 11 Home, 64-bit
- Windows 11 Home in S-mode, 32-bit

Memory

The following table lists the memory specifications of your Inspiron 14 7430 2-in-1.

Table 6. Memory specifications

Description	Values
Memory slots	None, on-board memory
Memory type	LPDDR5, dual-channel
Memory speed	4800 MHz
Maximum memory configuration	16 GB
Minimum memory configuration	8 GB
Memory configurations supported	<ul style="list-style-type: none">• 8 GB, LPDDR5, 4800 MHz, dual-channel• 16 GB, LPDDR5, 4800 MHz, dual-channel

External ports

The following table lists the external ports on your Inspiron 14 7430 2-in-1.

Table 7. External ports

Description	Values
USB ports	<ul style="list-style-type: none">• One USB 3.2 Gen 1 (5 Gbps) port

Table 7. External ports (continued)

Description	Values
	<ul style="list-style-type: none"> One Thunderbolt 4.0 port with Power Delivery (primary power) One Thunderbolt 4.0 port with Power Delivery
Audio port	One Universal audio jack
Video port/ports	One HDMI 1.4 port
Media-card reader	One SD-card slot
Power-adaptor port	One Thunderbolt 4.0 port with Power Delivery (primary power)
Security-cable slot	Not supported

Internal slots

The following table lists the internal slots of your Inspiron 14 7430 2-in-1.

Table 8. Internal slots

Description	Values
M.2	<ul style="list-style-type: none"> One M.2 slot for M.2 2230 WiFi and Bluetooth combo card One M.2 slot for M.2 2230/2280 solid-state drive <p>NOTE: To learn more about the features of different types of M.2 cards, search in the Knowledge Base Resource at www.dell.com/support.</p>

Wireless module

The following table lists the Wireless Local Area Network (WLAN) modules supported on your Inspiron 14 7430 2-in-1.

Table 9. Wireless module specifications

Description	Option one	Option two
Model number	Intel AX201	Intel AX211
Transfer rate	Up to 2400 Mbps	Up to 2400 Mbps
Frequency bands supported	2.4 GHz/5 GHz	2.4 GHz/5 GHz/6 GHz
Wireless standards	<ul style="list-style-type: none"> WiFi 802.11a/b/g Wi-Fi 4 (WiFi 802.11n) Wi-Fi 5 (WiFi 802.11ac) Wi-Fi 6 (WiFi 802.11ax) 	<ul style="list-style-type: none"> WiFi 802.11a/b/g Wi-Fi 4 (WiFi 802.11n) Wi-Fi 5 (WiFi 802.11ac) Wi-Fi 6E (WiFi 802.11ax)
Encryption	<ul style="list-style-type: none"> 64-bit/128-bit WEP AES-CCMP TKIP 	<ul style="list-style-type: none"> 64-bit/128-bit WEP AES-CCMP TKIP
Bluetooth	Bluetooth 5.2	Bluetooth 5.3

Table 9. Wireless module specifications (continued)

Description	Option one	Option two
		 NOTE: Particular versions of Microsoft Windows may not support the full Bluetooth 5.3 functionality.

Audio

The following table lists the audio specifications of your Inspiron 14 7430 2-in-1.

Table 10. Audio specifications

Description	Values	
Audio controller	Waves MaxxAudio Pro and Dolby Atmos Core	
Stereo conversion	Supported	
Internal audio interface	High-definition audio	
External audio interface	One Universal audio jack	
Number of speakers	Two	
Internal-speaker amplifier	Supported (audio codec integrated)	
External volume controls	Keyboard shortcut controls	
Speaker output:		
	Average speaker output	2 W x 2 = 4 W
	Peak speaker output	2.5 W x 2 = 5 W
Subwoofer output	Supported	
Microphone	Dual-array microphones in camera assembly	

Storage

This section lists the storage options on your Inspiron 14 7430 2-in-1.

Your Inspiron 14 7430 2-in-1 supports one of the following storage configurations:

- One M.2 2230 solid-state drive
- One M.2 2280 solid-state drive

The primary drive of your Inspiron 14 7430 2-in-1 varies with the storage configuration. For computers with a M.2 solid-state drive, the primary drive is the M.2 drive with the operating system installed.

Table 11. Storage specifications

Storage type	Interface type	Capacity
M.2 2230 solid-state drive	PCIe Gen3 x4 NVMe, up to 32 Gbps	Up to 1 TB
M.2 2230 solid-state drive	PCIe Gen4 x4 NVMe, up to 64 Gbps	Up to 1 TB
M.2 2280 solid-state drive	PCIe Gen4 x4 NVMe, up to 64 Gbps	Up to 2 TB

Table 11. Storage specifications (continued)

Storage type	Interface type	Capacity
M.2 2230 solid-state drive	PCIe Gen4 x4 NVMe, QLC, up to 64 Gbps	Up to 1 TB

Media-card reader

The following table lists the media cards supported by your Inspiron 14 7430 2-in-1.

Table 12. Media-card reader specifications

Description	Values
Media-card type	One SD-card slot
Media-cards supported	<ul style="list-style-type: none">Secure Digital (SD)Secure Digital High Capacity (SDHC)Secure Digital Extended Capacity (SDXC)
 NOTE: The maximum capacity supported by the media-card reader varies depending on the standard of the media card installed in your computer.	

Keyboard

The following table lists the keyboard specifications of your Inspiron 14 7430 2-in-1.

Table 13. Keyboard specifications

Description	Values
Keyboard type	<ul style="list-style-type: none">Standard backlit keyboard without fingerprint readerStandard backlit keyboard with fingerprint reader
Keyboard layout	QWERTY
Number of keys	<ul style="list-style-type: none">United States and Canada: 79 keysUnited Kingdom: 80 keysJapan: 83 keys
Keyboard size	X=19.05 mm key pitch Y=19.05 mm key pitch
Keyboard shortcuts	Some keys on your keyboard have two symbols on them. These keys can be used to type alternate characters or to perform secondary functions. To type the alternate character, press Shift and the desired key. To perform secondary functions, press fn and the desired key. For more information, see Keyboard shortcuts .

Keyboard function keys

The **F1-F12** keys at the top of the keyboard are function keys. By default, these keys are used to perform specific functions defined by the software application in use.

You can run the secondary tasks that are indicated by the symbols on the function keys by pressing the function key with **fn**, for example, **fn** and **F1**. See the table below for the list of secondary tasks and the key combinations to run them.

NOTE: Keyboard characters may differ depending on the keyboard language configuration. Keys that are used for tasks remain the same, regardless of the keyboard language.

Table 14. Secondary tasks of keyboard keys

Key combination for task	What the task does
fn and F1	Mutes audio
fn and F2	Decreases audio volume
fn and F3	Increases audio volume
fn and F4	Plays or pauses media file
fn and F5	Enables or disables keyboard lighting
fn and F6	Decreases display brightness
fn and F7	Increases display brightness
fn and F8	Switches to an external display
fn and F10	Prints screen (Screen capture)
fn and F11	Home (Moves cursor to beginning of the line)
fn and F12	End (Moves cursor to the end of the line)
fn and Esc	Locks or unlocks the fn key
fn and Ctrl	Opens the menu of the software application

Keys with alternate characters

There are other keys on your keyboard with alternate characters. The symbols that are shown at the bottom of these keys are the main characters that are displayed when the key is pressed; the symbols that are shown at the top of these keys are displayed when the key is pressed with the shift key. For example, if you press **2**, **2** is displayed; if you press **Shift** and **2**, **@** is displayed.

Camera

The following table lists the camera specifications of your Inspiron 14 7430 2-in-1.

Table 15. Camera specifications

Description	Values
Number of cameras	One
Camera type	FHD+ RGB
Camera location	Front
Camera sensor type	CMOS sensor technology
Camera resolution:	
Still image	2.07 megapixel
Video	1920 x 1080 (FHD) at 30 fps
Diagonal viewing angle:	82 degrees

Touchpad

The following table lists the touchpad specifications of your Inspiron 14 7430 2-in-1.

Table 16. Touchpad specifications

Description		Values
Touchpad resolution:		> 300 dpi
Touchpad dimensions:		
	Horizontal	115 mm (4.53 in.)
	Vertical	80 mm (3.15 in.)
Touchpad gestures		For more information about touchpad gestures available on Windows, see the Microsoft knowledge base article at support.microsoft.com .

Power adapter

The following table lists the power adapter specifications of your Inspiron 14 7430 2-in-1.



Table 17. Power adapter specifications

Description		Values
Type		65 W USB Type-C adapter
Power-adapter dimensions:		
	Height	27.94 mm (1.10 in.)
	Width	50.80 mm (2.00 in.)
	Depth	111.76 mm (4.40 in.)
Input voltage		100 VAC–240 VAC
Input frequency		50 Hz–60 Hz
Input current (maximum)		1.70 A
Output current (continuous)		<ul style="list-style-type: none"> • 3 A • 3.25 A
Rated output voltage		<ul style="list-style-type: none"> • 20 V/3.25 A (continuous) • 15 V/3 A (continuous) • 9 V/3 A (continuous) • 5 V/3 A (continuous)
Temperature range:		
	Operating	0°C to 40°C (32°F to 104°F)
	Storage	-40°C to 70°C (-40°F to 158°F)
 CAUTION: Operating and storage temperature ranges may differ among components, so operating or storing the device outside these ranges may impact the performance of specific components.		

Battery

The following table lists the battery specifications of your Inspiron 14 7430 2-in-1.

Table 18. Battery specifications

Description		Option one	Option two
Battery type		4-cell "smart" lithium-ion, 54 Wh	4-cell "smart" lithium-ion, 64 Wh
Battery voltage		15 VDC	15.20 VDC
Battery weight (maximum)		0.235 kg (0.52 lb)	0.26 kg (0.57 lb)
Battery dimensions:			
	Height	271.90 mm (10.70 in.)	271.90 mm (10.70 in.)
	Width	82 mm (3.23 in.)	82 mm (3.23 in.)
	Depth	5.75 mm (0.23 in.)	5.75 mm (0.23 in.)
Temperature range:			
	Operating	<ul style="list-style-type: none"> Charge: 0°C to 45°C (32°F to 113°F) Discharge: 0°C to 70°C (32°F to 158°F) 	<ul style="list-style-type: none"> Charge: 0°C to 45°C (32°F to 113°F) Discharge: 0°C to 70°C (32°F to 158°F)
	Storage	-20°C to 60°C (-4°F to 140°F)	-20°C to 60°C (-4°F to 140°F)
Battery operating time		Varies depending on operating conditions and can significantly reduce under certain power-intensive conditions.	Varies depending on operating conditions and can significantly reduce under certain power-intensive conditions.
Battery charging time (approximate)  NOTE: Control the charging time, duration, start and end time, and so on using the Dell Power Manager application. For more information on the Dell Power Manager see, <i>Me and My Dell</i> on www.dell.com .		4 hours (when the computer is off)	4 hours (when the computer is off)
Coin-cell battery		CR-2032	CR-2032
 CAUTION: Operating and storage temperature ranges may differ among components, so operating or storing the device outside these ranges may impact the performance of specific components.			
 CAUTION: Dell recommends that you charge the battery regularly for optimal power consumption. If your battery charge is completely depleted, connect the power adapter, turn on your computer, and then restart your computer to reduce the power consumption.			

Display

The following table lists the display specifications of your Inspiron 14 7430 2-in-1.

Table 19. Display specifications

Description		Values
Display type		14-inch, Full High Definition Plus (FHD+), ComfortView
Touch options		Touch support, with 10 touch points
Display-panel technology		Wide Viewing Angle (WVA)
Display-panel dimensions (active area):		
	Height	188.50 mm
	Width	301.59 mm
	Diagonal	355.65 mm
Display-panel native resolution		1920 x 1200
Luminance (typical)		250 nits
Megapixels		2.3
Color gamut		45% NTSC, typical
Pixels Per Inch (PPI)		162
Contrast ratio (min)		800:1, typical
Response time (max)		35 ms, typical
Refresh rate		60 Hz
Horizontal view angle		<ul style="list-style-type: none"> • +/- 85 degrees, typical • +/- 80 degrees, minimum
Vertical view angle		<ul style="list-style-type: none"> • +/- 85 degrees, typical • +/- 80 degrees, minimum
Pixel pitch		0.1571 mm
Power consumption (maximum)		3.20 W
Anti-glare vs glossy finish		Anti-glare

Fingerprint reader (optional)

The following table lists the specifications of the optional fingerprint-reader of your Inspiron 14 7430 2-in-1.

Table 20. Fingerprint reader specifications

Description	Values
Fingerprint-reader sensor technology	Capacitive

Table 20. Fingerprint reader specifications (continued)

Description	Values
Fingerprint-reader sensor resolution	500 ppi
Fingerprint-reader sensor pixel size	108 x 88

GPU—Integrated

The following table lists the specifications of the integrated Graphics Processing Unit (GPU) supported by your Inspiron 14 7430 2-in-1.

Table 21. GPU—Integrated

Controller	Memory size	Processor
Intel UHD Graphics	Shared system memory	13 th Generation Intel Core i3
Intel Iris X ^e Graphics	Shared system memory	13 th Generation Intel Core i5/i7

External display support

The following table lists the external display support for your Inspiron 14 7430 2-in-1.

Table 22. External display support

Graphics card	Supported external displays with laptop display enabled	Supported external displays with laptop display disabled
Intel UHD Graphics	3	4
Intel Iris X ^e Graphics	3	4

NOTE: For more information about external display support, see the External Display Connection Guide on www.dell.com/support.

Operating and storage environment

This table lists the operating and storage specifications of your Inspiron 14 7430 2-in-1.

Airborne contaminant level: G1 as defined by ISA-S71.04-1985

Table 23. Computer environment

Description	Operating	Storage
Temperature range	0°C to 40°C (32°F to 104°F)	-40°C to 65°C (-40°F to 149°F)
Relative humidity (maximum)	50% to 90% (non-condensing)	20% to 95% (non-condensing)
Vibration (maximum)*	0.66 GRMS	Operational
Shock (maximum)	140 G†	Operational

CAUTION: Operating and storage temperature ranges may differ among components, so operating or storing the device outside these ranges may impact the performance of specific components.

* Measured using a random vibration spectrum that simulates user environment.

† Measured using a 2 ms half-sine pulse.

Dell Support policy

For information on Dell support policy, search in the Knowledge Base Resource at www.dell.com/support.

ComfortView

 **WARNING: Prolonged exposure to blue light from the display may lead to long-term effects such as eye strain, eye fatigue, or damage to the eyes.**

Blue light is a color in the light spectrum which has a short wavelength and high energy. Chronic exposure to blue light, particularly from digital sources, may disrupt sleep patterns and cause long-term effects such as eye strain, eye fatigue, or damage to the eyes.

ComfortView mode can be enabled and configured using the Dell CinemaColor application.

ComfortView mode complies with TÜV Rheinland's requirement for low blue light software solutions.

Low blue light: Dell ComfortView software technology reduces harmful blue light emissions to make extended screen time easy on your eyes.











To reduce the risk of eye strain, it is also recommended that you:

- Position the display at a comfortable viewing distance between 20 and 28 inches (50 and 70 cm) from your eyes.
- Blink frequently to moisten your eyes, wet your eyes with water, or apply suitable eye drops.
- Look away from your display, and gaze at a distant object at 20 ft (609.60 cm) away for at least 20 seconds during each break.
- Take an extended break for 20 minutes every two hours.

Working inside your computer



Safety instructions

Use the following safety guidelines to protect your computer from potential damage and to ensure your personal safety. Unless otherwise noted, each procedure included in this document assumes that you have read the safety information that shipped with your computer.

-  **WARNING:** Before working inside your computer, read the safety information that is shipped with your computer. For more safety best practices, see the Regulatory Compliance home page at www.dell.com/regulatory_compliance.
-  **WARNING:** Disconnect your computer from all power sources before opening the computer cover or panels. After you finish working inside the computer, replace all covers, panels, and screws before connecting your computer to an electrical outlet.
-  **CAUTION:** To avoid damaging the computer, ensure that the work surface is flat, dry, and clean.
-  **CAUTION:** To avoid damaging the components and cards, handle them by their edges, and avoid touching the pins and the contacts.
-  **CAUTION:** You should only perform troubleshooting and repairs as authorized or directed by the Dell technical assistance team. Damage due to servicing that is not authorized by Dell is not covered by your warranty. See the safety instructions that is shipped with the product or at www.dell.com/regulatory_compliance.
-  **CAUTION:** Before touching anything inside your computer, ground yourself by touching an unpainted metal surface, such as the metal at the back of the computer. While you work, periodically touch an unpainted metal surface to dissipate static electricity which could harm internal components.
-  **CAUTION:** When you disconnect a cable, pull it by its connector or its pull tab, not the cable itself. Some cables have connectors with locking tabs or thumbscrews that you must disengage before disconnecting the cable. When disconnecting cables, keep them evenly aligned to avoid bending the connector pins. When connecting cables, ensure that the ports and the connectors are correctly oriented and aligned.
-  **CAUTION:** Press and eject any installed card from the media-card reader.
-  **CAUTION:** Exercise caution when handling Lithium-ion batteries in laptops. Swollen batteries should not be used and should be replaced and disposed properly.
-  **NOTE:** The color of your computer and certain components may appear differently than shown in this document.

Before working inside your computer

Steps

1. Save and close all open files and exit all open applications.
2. Shut down your computer. For Windows operating system, click **Start** >  **Power** > **Shut down**.
 -  **NOTE:** If you are using a different operating system, see the documentation of your operating system for shut-down instructions.
3. Disconnect your computer and all attached devices from their electrical outlets.
4. Disconnect all attached network devices and peripherals, such as keyboard, mouse, and monitor from your computer.

5. Remove any media card and optical disk from your computer, if applicable.
6. Enter the service mode, if you are able to power on your computer.

Service Mode

Service Mode is used to cut-off power, without disconnecting battery cable from system board prior conducting repairs in the computer.

CAUTION: If you are unable to turn on the computer to put it into Service Mode or the computer does not support Service Mode then proceed to disconnect the battery cable. To disconnect the battery cable, follow the steps in [Removing the battery](#).

NOTE: Ensure that your computer is shut down and the AC adapter is disconnected.

- a. Hold **** key on the keyboard and press the power button for 3 seconds or until the Dell logo appears on the screen.
- b. Press any key to continue.
- c. If the AC adapter is not disconnected, a message prompting you to remove the AC adapter appears on the screen. Remove the AC adapter and then press any key to continue the **Service Mode** procedure. The **Service Mode** procedure automatically skips the following step if the **Owner Tag** of the computer is not set up in advance by the user.
- d. When the ready-to-proceed message appears on the screen, press any key to proceed. The computer emits three short beeps and shuts down immediately.
- e. Once the computer shuts down, it has successfully entered Service Mode.

NOTE: If you are unable to power on your computer or unable to enter service mode skip this process.

Safety precautions

The safety precautions chapter details the primary steps to be taken before performing any disassembly instructions.

Observe the following safety precautions before you perform any installation or break/fix procedures involving disassembly or reassembly:

- Turn off the system and all attached peripherals.
- Disconnect the system and all attached peripherals from AC power.
- Disconnect all network cables, telephone, and telecommunications lines from the system.
- Use an ESD field service kit when working inside any to avoid electrostatic discharge (ESD) damage.
- After removing any system component, carefully place the removed component on an anti-static mat.
- Wear shoes with non-conductive rubber soles to reduce the chance of getting electrocuted.

Standby power

Dell products with standby power must be unplugged before you open the case. Systems that incorporate standby power are essentially powered while turned off. The internal power enables the system to be remotely turned on (wake on LAN) and suspended into a sleep mode and has other advanced power management features.

Unplugging, pressing and holding the power button for 15 seconds should discharge residual power in the system board.

Bonding

Bonding is a method for connecting two or more grounding conductors to the same electrical potential. This is done through the use of a field service electrostatic discharge (ESD) kit. When connecting a bonding wire, ensure that it is connected to bare metal and never to a painted or non-metal surface. The wrist strap should be secure and in full contact with your skin, and ensure that you remove all jewelry such as watches, bracelets, or rings prior to bonding yourself and the equipment.

Electrostatic discharge—ESD protection

ESD is a major concern when you handle electronic components, especially sensitive components such as expansion cards, processors, memory DIMMs, and system boards. Very slight charges can damage circuits in ways that may not be obvious, such as intermittent problems or a shortened product life span. As the industry pushes for lower power requirements and increased density, ESD protection is an increasing concern.

Due to the increased density of semiconductors used in recent Dell products, the sensitivity to static damage is now higher than in previous Dell products. For this reason, some previously approved methods of handling parts are no longer applicable.

Two recognized types of ESD damage are catastrophic and intermittent failures.

- **Catastrophic** – Catastrophic failures represent approximately 20 percent of ESD-related failures. The damage causes an immediate and complete loss of device functionality. An example of catastrophic failure is a memory DIMM that has received a static shock and immediately generates a "No POST/No Video" symptom with a beep code emitted for missing or nonfunctional memory.
- **Intermittent** – Intermittent failures represent approximately 80 percent of ESD-related failures. The high rate of intermittent failures means that most of the time when damage occurs, it is not immediately recognizable. The DIMM receives a static shock, but the tracing is merely weakened and does not immediately produce outward symptoms related to the damage. The weakened trace may take weeks or months to melt, and in the meantime may cause degradation of memory integrity, intermittent memory errors, etc.

The more difficult type of damage to recognize and troubleshoot is the intermittent (also called latent or "walking wounded") failure.

Perform the following steps to prevent ESD damage:

- Use a wired ESD wrist strap that is properly grounded. The use of wireless anti-static straps is no longer allowed; they do not provide adequate protection. Touching the chassis before handling parts does not ensure adequate ESD protection on parts with increased sensitivity to ESD damage.
- Handle all static-sensitive components in a static-safe area. If possible, use anti-static floor pads and workbench pads.
- When unpacking a static-sensitive component from its shipping carton, do not remove the component from the anti-static packing material until you are ready to install the component. Before unwrapping the anti-static packaging, ensure that you discharge static electricity from your body.
- Before transporting a static-sensitive component, place it in an anti-static container or packaging.

ESD field service kit

The unmonitored Field Service kit is the most commonly used service kit. Each Field Service kit includes three main components: anti-static mat, wrist strap, and bonding wire.

Components of an ESD field service kit

The components of an ESD field service kit are:

- **Anti-Static Mat** – The anti-static mat is dissipative and parts can be placed on it during service procedures. When using an anti-static mat, your wrist strap should be snug and the bonding wire should be connected to the mat and to any bare metal on the system being worked on. Once deployed properly, service parts can be removed from the ESD bag and placed directly on the mat. ESD-sensitive items are safe in your hand, on the ESD mat, in the system, or inside a bag.
- **Wrist Strap and Bonding Wire** – The wrist strap and bonding wire can be either directly connected between your wrist and bare metal on the hardware if the ESD mat is not required, or connected to the anti-static mat to protect hardware that is temporarily placed on the mat. The physical connection of the wrist strap and bonding wire between your skin, the ESD mat, and the hardware is known as bonding. Use only Field Service kits with a wrist strap, mat, and bonding wire. Never use wireless wrist straps. Always be aware that the internal wires of a wrist strap are prone to damage from normal wear and tear, and must be checked regularly with a wrist strap tester in order to avoid accidental ESD hardware damage. It is recommended to test the wrist strap and bonding wire at least once per week.
- **ESD Wrist Strap Tester** – The wires inside of an ESD strap are prone to damage over time. When using an unmonitored kit, it is a best practice to regularly test the strap prior to each service call, and at a minimum, test once per week. A wrist strap tester is the best method for doing this test. If you do not have your own wrist strap tester, check with your regional office to find out if they have one. To perform the test, plug the wrist-strap's bonding-wire into the tester while it is strapped to your wrist and push the button to test. A green LED is lit if the test is successful; a red LED is lit and an alarm sounds if the test fails.
- **Insulator Elements** – It is critical to keep ESD sensitive devices, such as plastic heat sink casings, away from internal parts that are insulators and often highly charged.
- **Working Environment** – Before deploying the ESD Field Service kit, assess the situation at the customer location. For example, deploying the kit for a server environment is different than for a desktop or portable environment. Servers are typically installed in a rack within a data center; desktops or portables are typically placed on office desks or cubicles. Always look for a large open flat work area that is free of clutter and large enough to deploy the ESD kit with additional space to accommodate the type of system that is being repaired. The workspace should also be free of insulators that can cause an ESD event. On the work area, insulators such as Styrofoam and other plastics should always be moved at least 12 inches or 30 centimeters away from sensitive parts before physically handling any hardware components

- **ESD Packaging** – All ESD-sensitive devices must be shipped and received in static-safe packaging. Metal, static-shielded bags are preferred. However, you should always return the damaged part using the same ESD bag and packaging that the new part arrived in. The ESD bag should be folded over and taped shut and all the same foam packing material should be used in the original box that the new part arrived in. ESD-sensitive devices should be removed from packaging only at an ESD-protected work surface, and parts should never be placed on top of the ESD bag because only the inside of the bag is shielded. Always place parts in your hand, on the ESD mat, in the system, or inside an anti-static bag.
- **Transporting Sensitive Components** – When transporting ESD sensitive components such as replacement parts or parts to be returned to Dell, it is critical to place these parts in anti-static bags for safe transport.

ESD protection summary

It is recommended to use the traditional wired ESD grounding wrist strap and protective anti-static mat at all times when servicing Dell products. In addition, it is critical to keep sensitive parts separate from all insulator parts while performing service and that they use anti-static bags for transporting sensitive components.

Transporting sensitive components

When transporting ESD sensitive components such as replacement parts or parts to be returned to Dell, it is critical to place these parts in anti-static bags for safe transport.

After working inside your computer

About this task

 **CAUTION:** Leaving stray or loose screws inside your computer may severely damage your computer.

Steps

1. Replace all screws and ensure that no stray screws remain inside your computer.
2. Connect any external devices, peripherals, or cables you removed before working on your computer.
3. Replace any media cards, discs, or any other parts that you removed before working on your computer.
4. Connect your computer and all attached devices to their electrical outlets.
 - ① **NOTE:** To exit service mode, ensure to connect the AC adapter to the power-adapter port on your computer.
5. Press the power button to turn on the computer. Your computer will automatically return to normal functioning mode.

BitLocker

 **CAUTION:** If BitLocker is not suspended before updating the BIOS, the next time you reboot the system it will not recognize the BitLocker key. You will then be prompted to enter the recovery key to progress, and the system will ask for this on each reboot. If the recovery key is not known this can result in data loss or an unnecessary operating system reinstall. For more information about this subject, see Knowledge Article: [updating the BIOS on Dell systems with BitLocker enabled](#).

The installation of the following components triggers BitLocker:

- Hard disk drive or solid state drive
- System board

Recommended tools

The procedures in this document may require the following tools:

- Phillips screwdriver #0
- Phillips screwdriver #1
- Plastic scribe

Screw list

- NOTE:** When removing screws from a component, it is recommended to note the screw type, the quantity of screws, and then place them in a screw storage box. This is to ensure that the correct number of screws and correct screw type is restored when the component is replaced.
- NOTE:** Some computers have magnetic surfaces. Ensure that the screws are not left attached to such surfaces when replacing a component.
- NOTE:** Screw color may vary with the configuration ordered.

Table 24. Screw list











Component	Screw type	Quantity	Screw image
Base cover	M2x4	4	
Base cover	Captive screw	3	
Battery	M2x3	5	
M.2 2230 mounting bracket	M2x1.8	1	
M.2 2230 solid-state drive	M2x3	1	
M.2 2280 solid-state drive	M2x3	1	
Fan	M2x3	2	
Wireless-card bracket	M2x3	1	
I/O board	M2x3	1	
Display hinges	M2.5x4	5	
Display hinges	M2x4	1	
Heat sink without discrete graphics	Captive screw	4	
Power-button board	M2x3	1	
System board	M2x1.8	2	
USB Type-C bracket	M2x4	2	
Touchpad	M2x2	4	

Table 24. Screw list (continued)

Component	Screw type	Quantity	Screw image
Touchpad	M1.6x2.5	5	

Major components of Inspiron 14 7430 2-in-1

The following image shows the major components of Inspiron 14 7430 2-in-1.

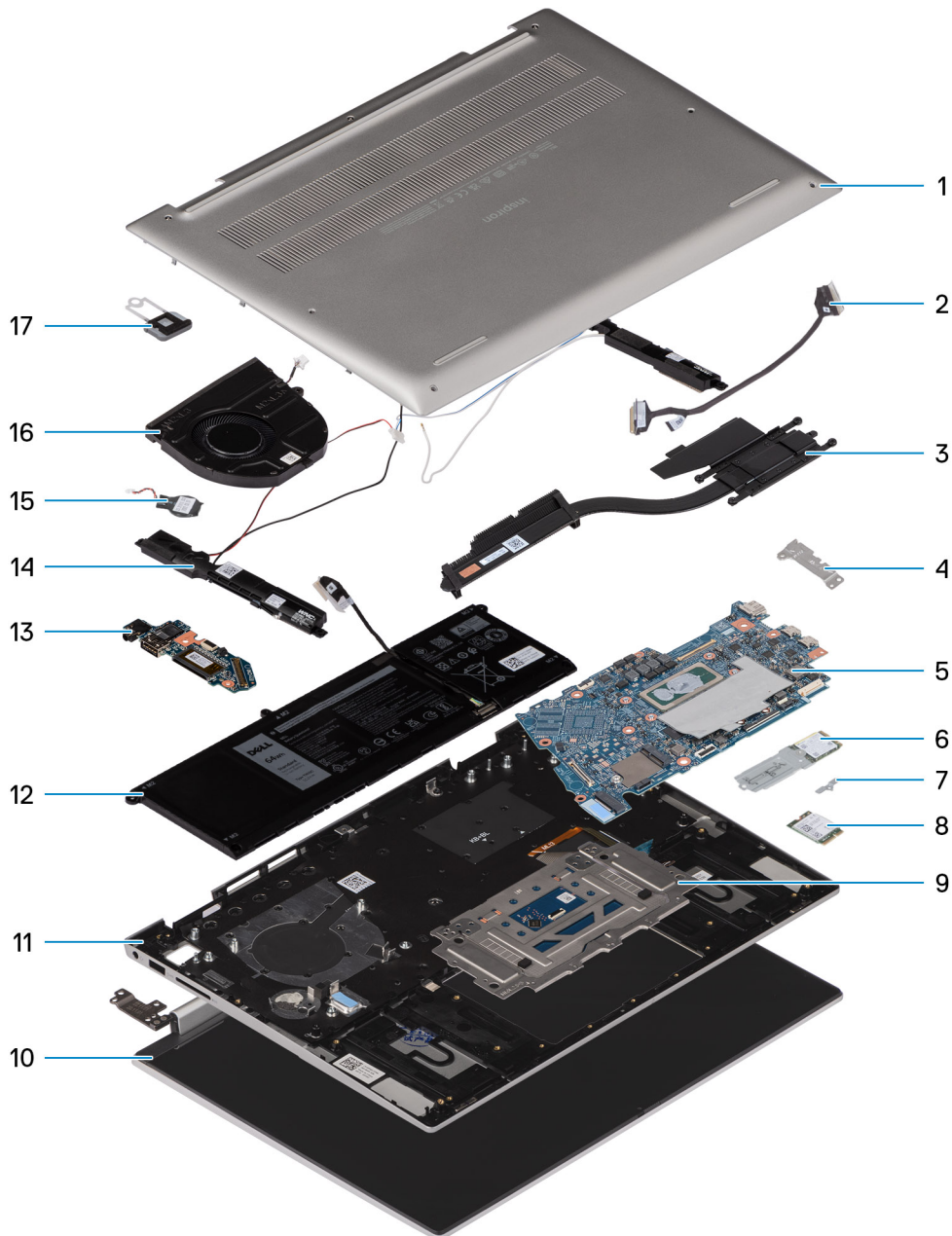

- 1. Base cover
- 3. Heat sink

- 2. I/O board cable
- 4. USB Type-C bracket

5. System board
7. Wireless-card bracket
9. Touchpad
11. Palm-rest and keyboard assembly
13. I/O board
15. Coin-cell battery
17. Power button
6. M.2 2230 solid-state drive
8. Wireless card
10. Display assembly
12. Battery
14. Speakers
16. Fan

 **NOTE:** Dell provides a list of components and their part numbers for the original system configuration purchased. These parts are available according to warranty coverages purchased by the customer. Contact your Dell sales representative for purchase options.

Removing and installing Customer Replaceable Units (CRUs)

The replaceable components in this chapter are Customer Replaceable Units (CRUs).

CAUTION: Customers can replace only the Customer Replaceable Units (CRUs) following the safety precautions and replacement procedures.

NOTE: The images in this document may differ from your computer depending on the configuration you ordered.

Base cover

Removing the base cover

Prerequisites

1. Follow the procedure in [Before working inside your computer](#).

About this task

NOTE: Before removing the base cover, ensure that there is no SD card installed in the SD-card slot on your computer.

The following images indicate the location of the base cover and provide a visual representation of the removal procedure.



3x



4x
M2x4

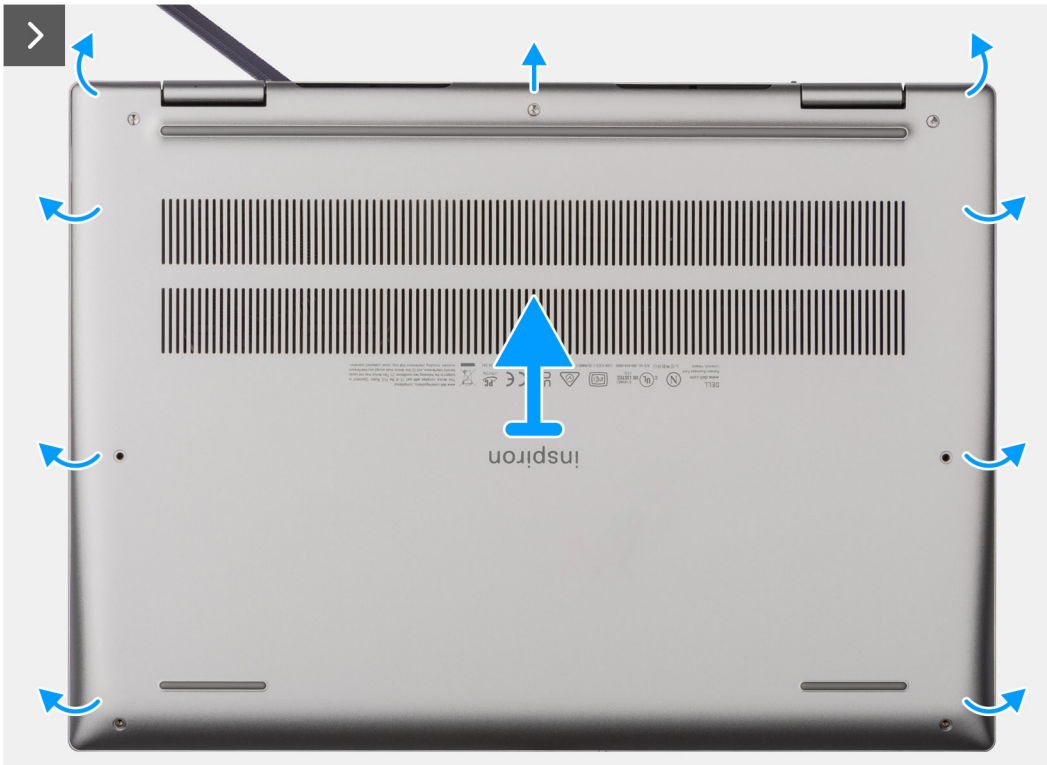

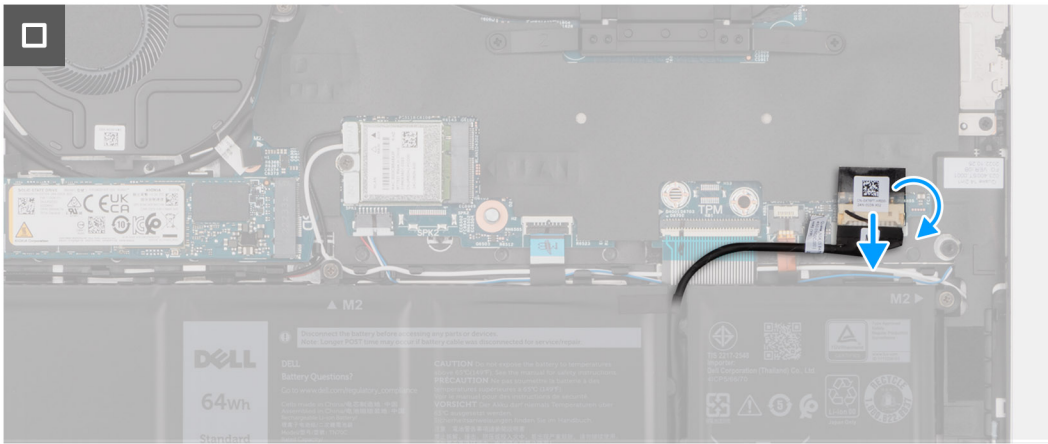

Steps

1. Remove the four screws (M2x4) that secure the base cover to the palm-rest and keyboard assembly.
2. Loosen the three captive screws that secure the base cover to the palm-rest and keyboard assembly.
NOTE: Upon loosening the captive screws, the base cover will open up creating a gap between the base cover and the palm-rest assembly at the hinges.
3. Starting from the top-left corner at the hinge, pry the base cover to release the base cover from the palm-rest and keyboard assembly.
4. Lift the base cover off the palm-rest and keyboard assembly.
5. Peel the tape that secures the battery cable to the system board and disconnect the battery cable from the connector on the system board.

Installing the base cover

Prerequisites

If you are replacing a component, remove the existing component before performing the installation procedure.

About this task

The following images indicate the location of the base cover and provide a visual representation of the installation procedure.

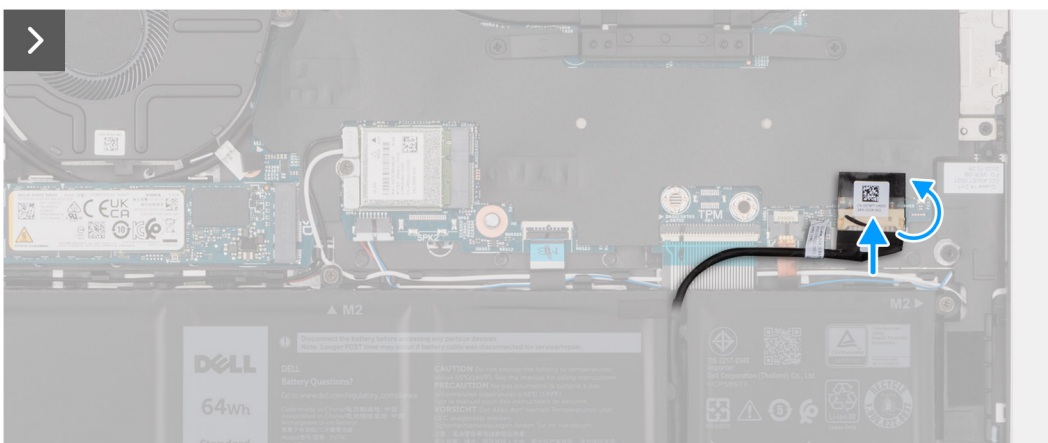

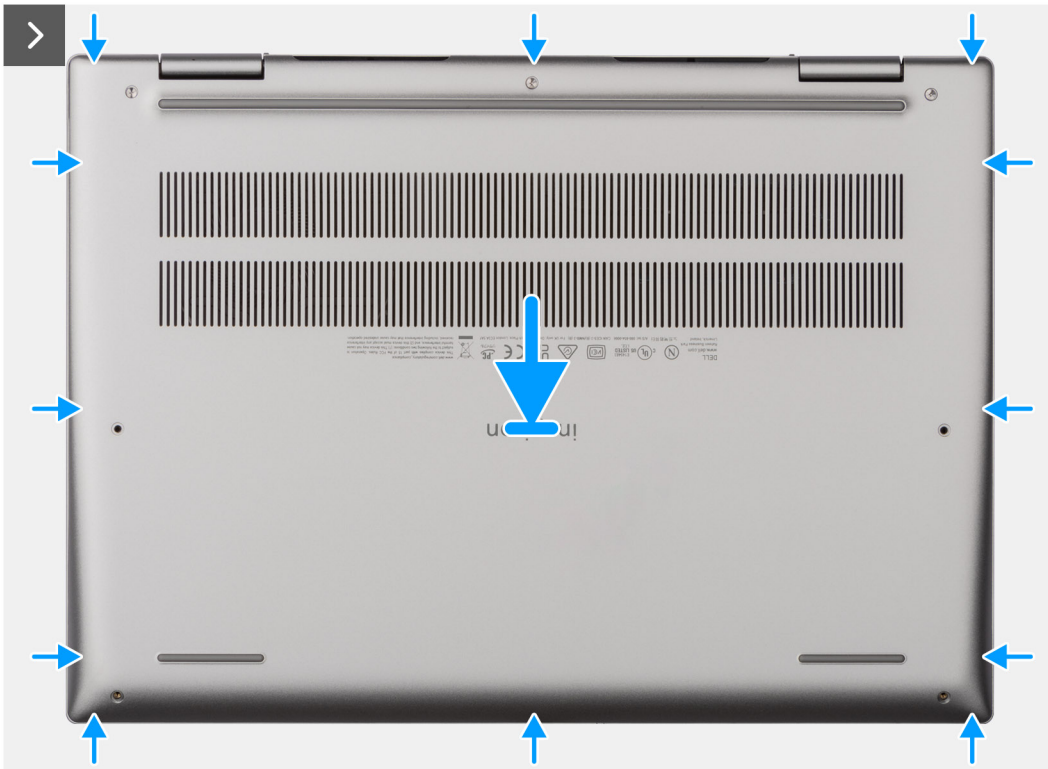

3x



4x
M2x4



Steps

1. Connect the battery cable to the connector on the system board and adhere the tape that secures the battery cable to the battery.
2. Align the screw holes on the base cover with the screw holes on the palm-rest and keyboard assembly, and then snap the base cover into place.
3. Tighten the three captive screws that secure the base cover to the palm-rest and keyboard assembly.
4. Replace the four screws (M2x4) that secure the base cover to the palm-rest and keyboard assembly.

Next steps

1. Follow the procedure in [After working inside your computer](#).

Solid-state drive

Removing the M.2 2230 solid-state drive

Prerequisites

1. Follow the procedure in [Before working inside your computer](#).
2. Remove the [base cover](#).

About this task

NOTE: This procedure applies only to computers shipped with an M.2 2230 solid-state drive installed.

NOTE: The M.2 card installed on your computer will depend on the configuration ordered. Supported card configurations on the M.2 card slot:

- M.2 2230 solid-state drive + M.2 2230 solid-state drive mounting bracket
- M.2 2280 solid-state drive

The following image indicates the location of the M.2 2230 solid-state drive and provides a visual representation of the removal procedure.



1x
M2x3



1x
M2x1.8

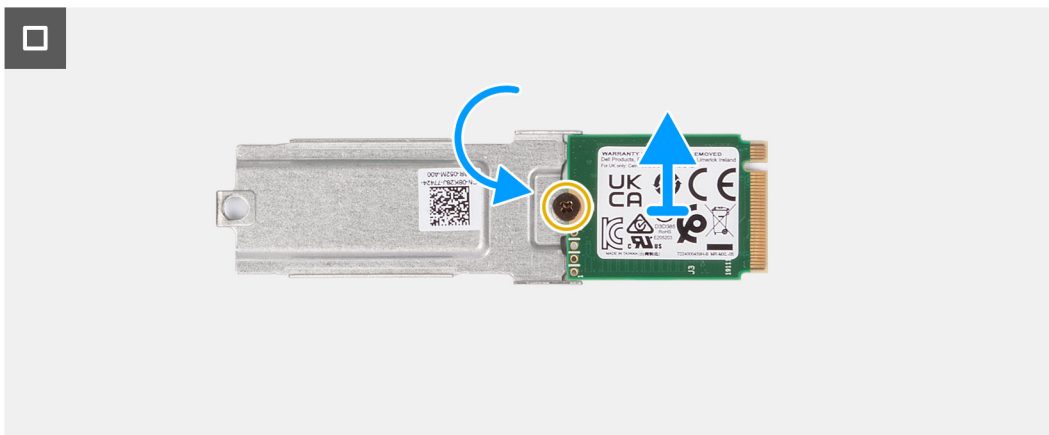
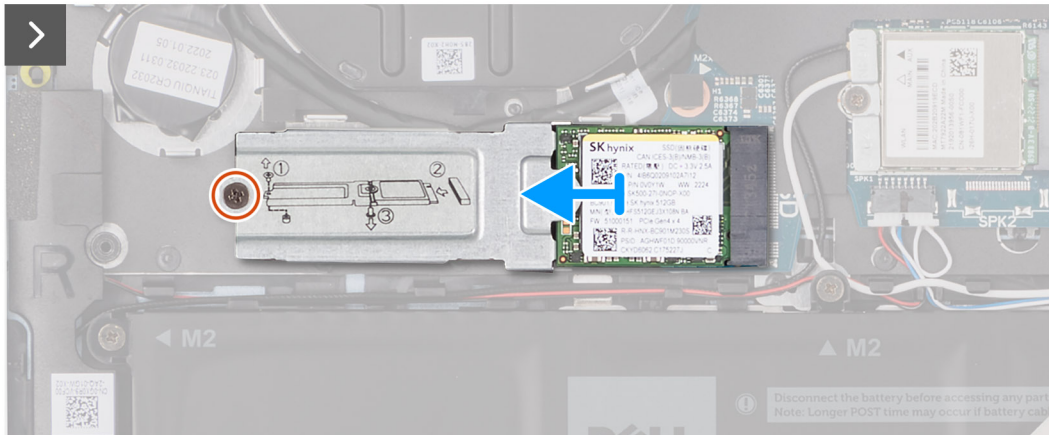
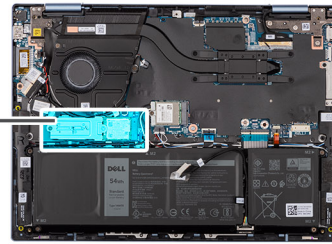

Steps

1. Remove the screw (M2x3) that secures the M.2 2230 solid-state drive assembly to the system board.
2. Slide and lift the M.2 2230 solid-state drive assembly off the system board.
3. Flip over the M.2 2230 solid-state drive assembly.
4. Remove the screw (M2x1.8) that secures the M.2 2230 solid-state drive to the M.2 2230 solid-state drive mounting bracket.
5. Lift the M.2 2230 solid-state drive off the M.2 2230 solid-state drive mounting bracket.

Installing the M.2 2230 solid-state drive

Prerequisites

If you are replacing a component, remove the existing component before performing the installation procedure.

About this task

- NOTE:** This procedure applies only to computers shipped with an M.2 2230 solid-state drive installed.
- NOTE:** The M.2 card installed on your computer will depend on the configuration ordered. Supported card configurations on the M.2 card slot:

- M.2 2230 solid-state drive + M.2 2230 solid-state drive mounting bracket
- M.2 2280 solid-state drive

The following image indicates the location of the M.2 2230 solid-state drive and provides a visual representation of the installation procedure.

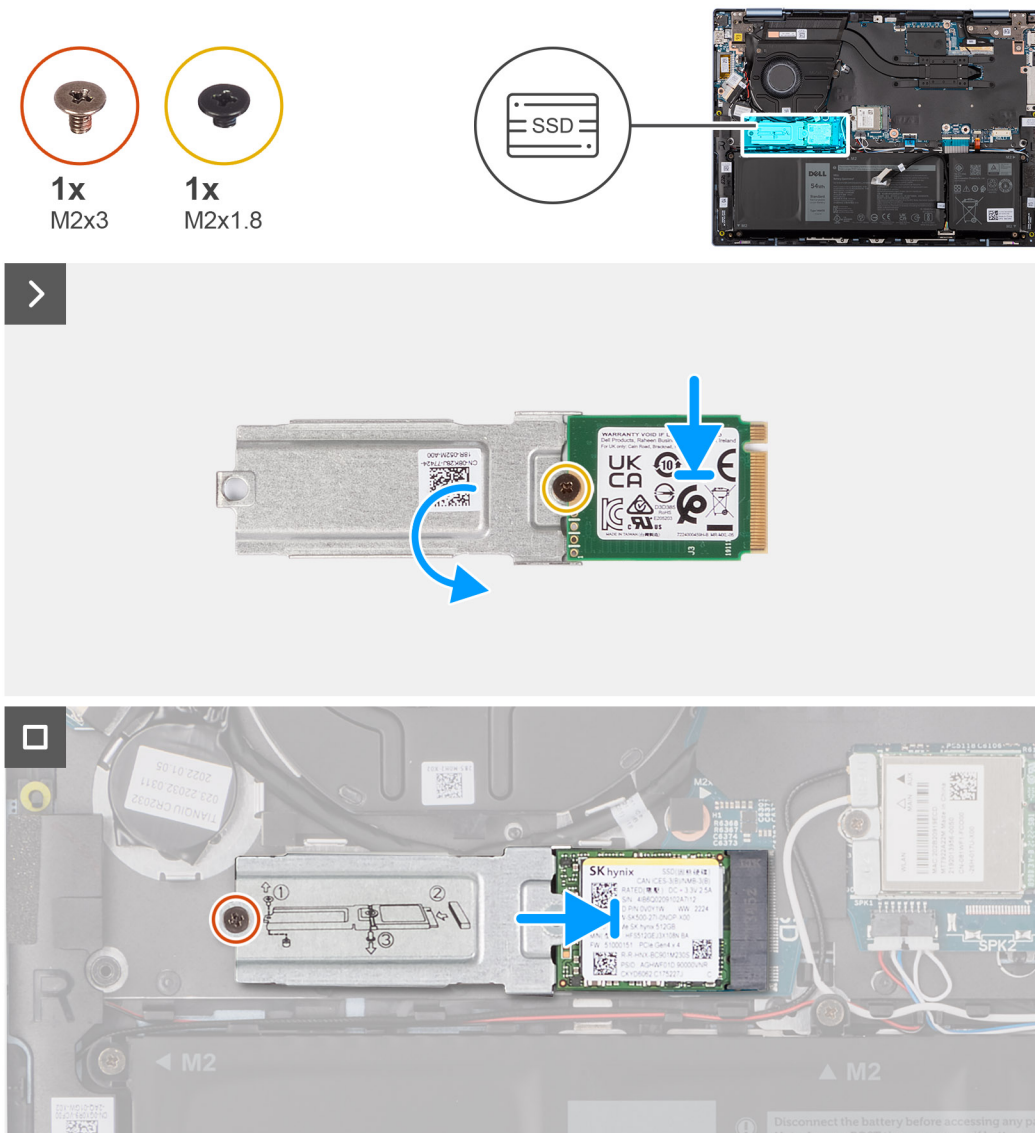

Steps

1. Place and align the M.2 2230 solid-state drive on the M.2 2230 solid-state drive mounting bracket
2. Replace the screw (M2x1.8) that secures the M.2 2230 solid-state drive to the M.2 2230 solid-state drive mounting bracket.
3. Flip over the M.2 2230 solid-state drive assembly.
4. Align the notch on the M.2 2230 solid-state drive with the tab on the M.2 solid-state drive slot on the system board.
5. Slide and place the M.2 2230 solid-state drive in the M.2 solid-state drive slot on the system board.
6. Replace the screw (M2x3) that secures the M.2 2230 solid-state drive assembly to the palm-rest and keyboard assembly.

Next steps

1. Install the [base cover](#).
2. Follow the procedure in [After working inside your computer](#).

Removing the M.2 2280 solid-state drive

Prerequisites

1. Follow the procedure in [Before working inside your computer](#).
2. Remove the [base cover](#).

About this task

- NOTE:** This procedure applies only to computers shipped with an M.2 2280 solid-state drive installed.
- NOTE:** The M.2 card installed on your computer will depend on the configuration ordered. Supported card configurations on the M.2 card slot:
 - M.2 2230 solid-state drive + M.2 2230 solid-state drive mounting bracket
 - M.2 2280 solid-state drive

The following image indicates the location of the M.2 2280 solid-state drive and provides a visual representation of the removal procedure.

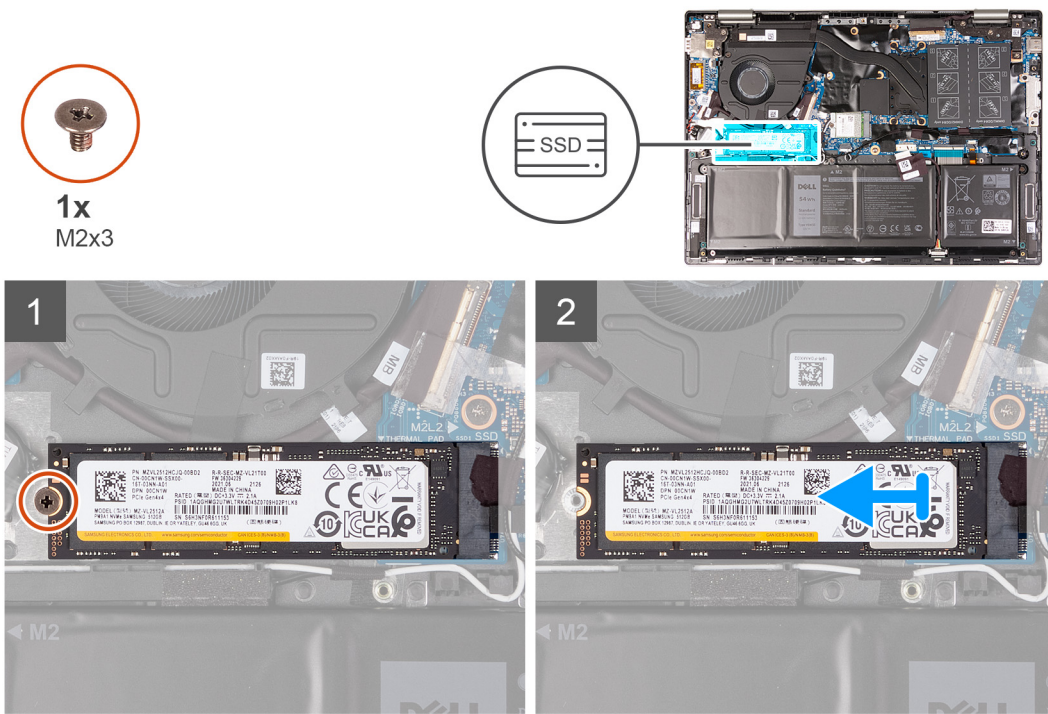

Steps

1. Remove the screw (M2x3) that secures the solid-state drive to the palm-rest and keyboard assembly.
2. Slide and lift the M.2 2280 solid-state drive off the system board.

Installing the M.2 2280 solid-state drive

Prerequisites

If you are replacing a component, remove the existing component before performing the installation procedure.

About this task

- NOTE:** This procedure applies if you are installing a M.2 2280 solid-state drive.
- NOTE:** The M.2 card installed on your computer will depend on the configuration ordered. Supported card configurations on the M.2 card slot:

- M.2 2230 solid-state drive + M.2 2230 solid-state drive mounting bracket
- M.2 2280 solid-state drive

The following image indicates the location of the M.2 2280 solid-state drive and provides a visual representation of the installation procedure.

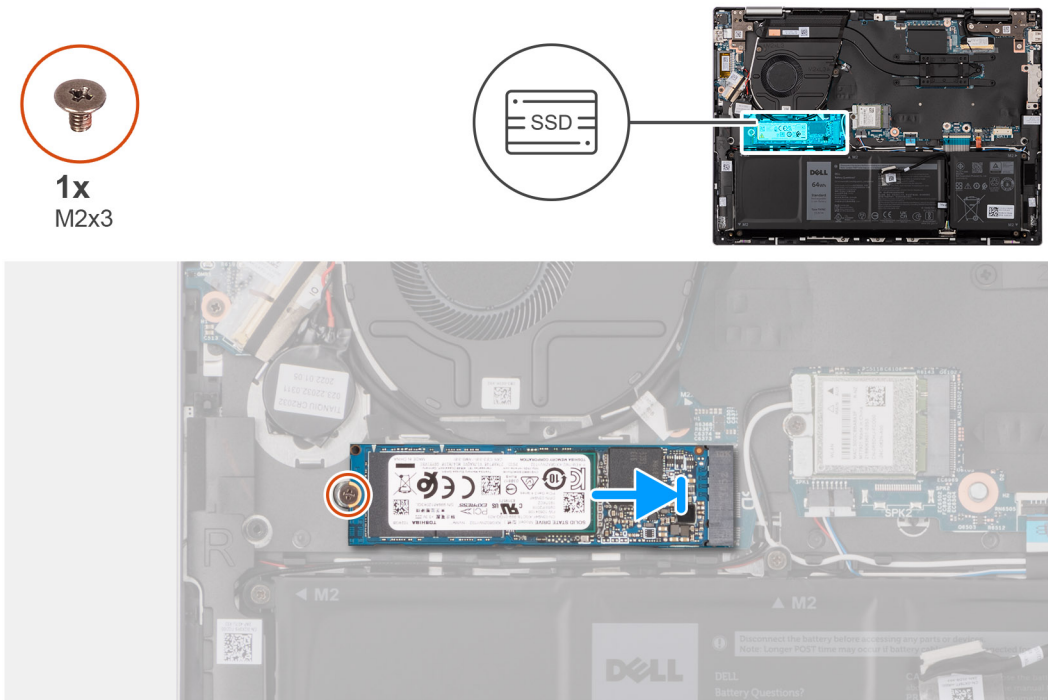

Steps

1. Align the notch on the M.2 2280 solid-state drive with the tab on the M.2 solid-state drive slot on the system board.
2. Slide the M.2 2280 solid-state drive into the M.2 solid-state drive slot on the system board.
3. Replace the screw (M2x3) that secures the M.2 2280 solid-state drive to the system board.

Next steps

1. Install the [base cover](#).
2. Follow the procedure in [After working inside your computer](#).

Wireless card

Removing the wireless card

Prerequisites

1. Follow the procedure in [Before working inside your computer](#).
2. Remove the [base cover](#).

About this task

The following image indicates the location of the wireless card and provides a visual representation of the removal procedure.



1x
M2x3

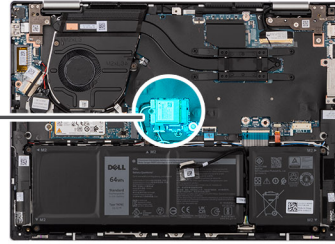

Steps

1. Remove the screw (M2x3) that secures the wireless-card bracket to the wireless card and system board.
2. Lift the wireless-card bracket off the wireless card.
3. Disconnect the antenna cables from the wireless card.
4. Slide and lift the wireless card off the system board.

Installing the wireless card

Prerequisites

If you are replacing a component, remove the existing component before performing the installation procedure.

About this task

The following image indicates the location of the wireless card and provides a visual representation of the installation procedure.



1x
M2x3

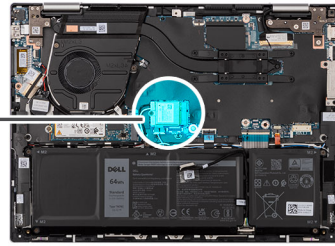

Steps

1. Connect the antenna cables to the wireless card.

The following table provides the antenna-cable color scheme for the wireless card that is supported by your computer.

Table 25. Antenna-cable color scheme

Connectors on the wireless card	Antenna-cable color	Silkscreen marking	
Main	White	MAIN	△ (white triangle)
Auxiliary	Black	AUX	▲ (black triangle)

2. Align the notch on the wireless card with the tab on the M.2 wireless-card slot on the system board.
3. Slide the wireless card into the M.2 wireless-card slot on the system board.
4. Place the wireless-card bracket on the wireless card and align the screw hole on the wireless-card bracket with the screw hole on the wireless card.
5. Replace the screw (M2x3) that secures the wireless card and wireless-card bracket to the system board.

Next steps

1. Install the [base cover](#).

2. Follow the procedure in [After working inside your computer](#).

Fan

Removing the fan

Prerequisites

1. Follow the procedure in [Before working inside your computer](#).
2. Remove the [base cover](#).

About this task

The following image indicates the location of the fan and provides a visual representation of the removal procedure.

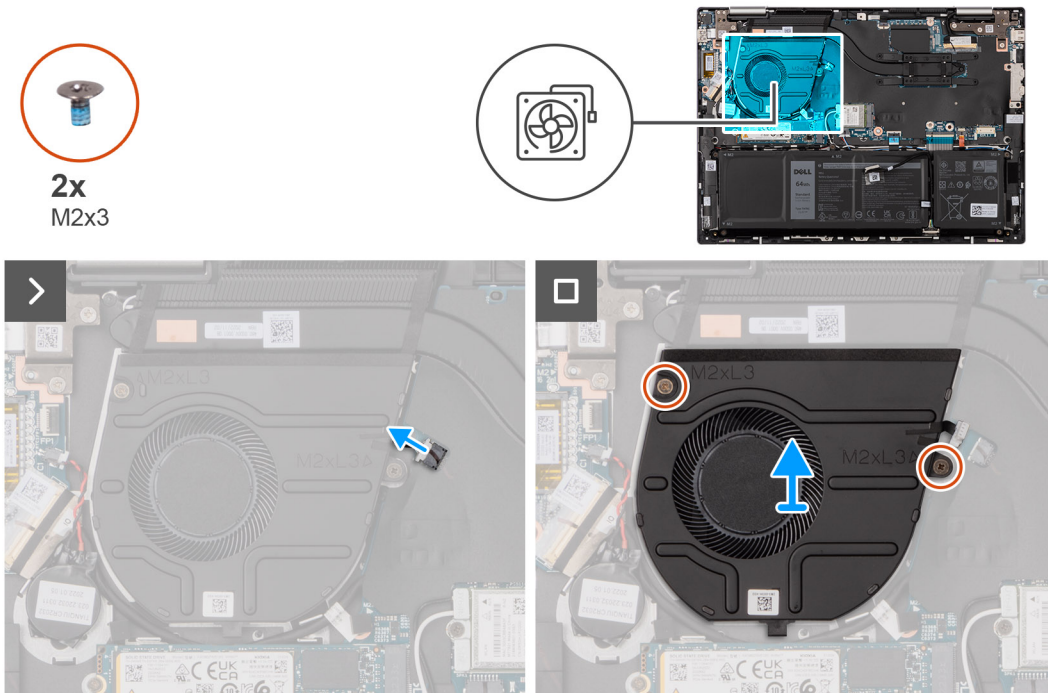

Steps

1. Disconnect the fan cable from the system board.
2. Remove the two screws (M2x3) that secure the fan to the palm-rest and keyboard assembly.
3. Lift the fan off the palm-rest and keyboard assembly.

Installing the fan

Prerequisites

If you are replacing a component, remove the existing component before performing the installation procedure.

About this task

The following image indicates the location of the fan and provides a visual representation of the installation procedure.



2x
M2x3

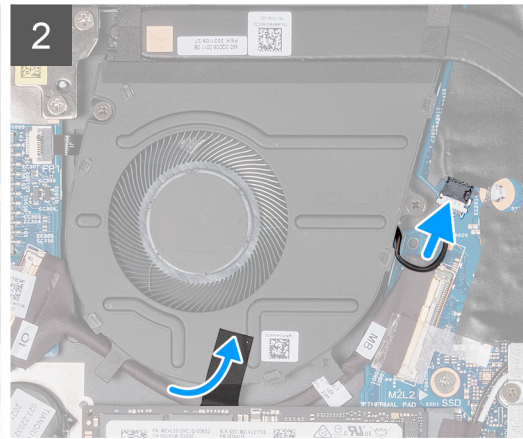
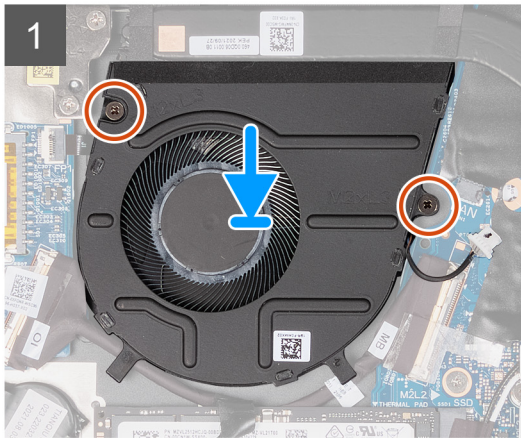
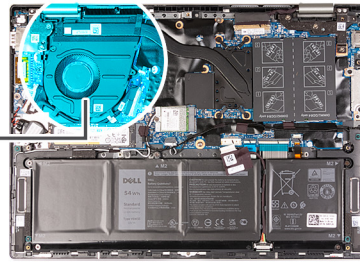
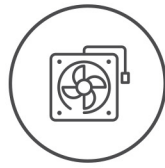

Steps

1. Place the fan on the palm-rest and keyboard assembly.
2. Align the screw holes on the fan with the screw holes on the palm-rest and keyboard assembly.
3. Remove the two screws (M2x3) that secure the fan to the palm-rest and keyboard assembly.
4. Connect the fan cable to the system board.

Next steps

1. Install the [base cover](#).
2. Follow the procedure in [After working inside your computer](#).

Removing and installing Field Replaceable Units (FRUs)

The replaceable components in this chapter are Field Replaceable Units (FRUs).

CAUTION: The information in this section is intended for authorized service technicians only.

CAUTION: To avoid any potential damage to the component or loss of data, ensure that an authorized service technician replaces the Field Replaceable Units (FRUs).

CAUTION: Dell Technologies recommends that this set of repairs, if needed, to be conducted by trained technical repair specialists.

CAUTION: As a reminder, your warranty does not cover damages that may occur during the courses of FRU repairs that are not authorized by Dell Technologies.

NOTE: The images in this document may differ from your computer depending on the configuration you ordered.

Battery

Lithium-ion battery precautions

CAUTION:

- Exercise caution when handling Lithium-ion batteries.
- Discharge the battery completely before removing it. Disconnect the AC power adapter from the system and operate the computer solely on battery power—the battery is fully discharged when the computer no longer turns on when the power button is pressed.
- Do not crush, drop, mutilate, or penetrate the battery with foreign objects.
- Do not expose the battery to high temperatures, or disassemble battery packs and cells.
- Do not apply pressure to the surface of the battery.
- Do not bend the battery.
- Do not use tools of any kind to pry on or against the battery.
- Ensure any screws during the servicing of this product are not lost or misplaced, to prevent accidental puncture or damage to the battery and other system components.
- If the battery gets stuck inside your computer as a result of swelling, do not try to release it as puncturing, bending, or crushing a lithium-ion battery can be dangerous. In such an instance, contact Dell technical support for assistance. See www.dell.com/contactdell.
- Always purchase genuine batteries from www.dell.com or authorized Dell partners and resellers.
- Swollen batteries should not be used and should be replaced and disposed properly. For guidelines on how to handle and replace swollen Lithium-ion batteries, see [Handling swollen Lithium-ion batteries](#).

Removing the battery

CAUTION: The information in this section is intended for authorized service technicians only.

Prerequisites

1. Follow the procedure in [Before working inside your computer](#).
2. Remove the [base cover](#).

About this task

The following image indicates the location of the battery and provides a visual representation of the removal procedure.

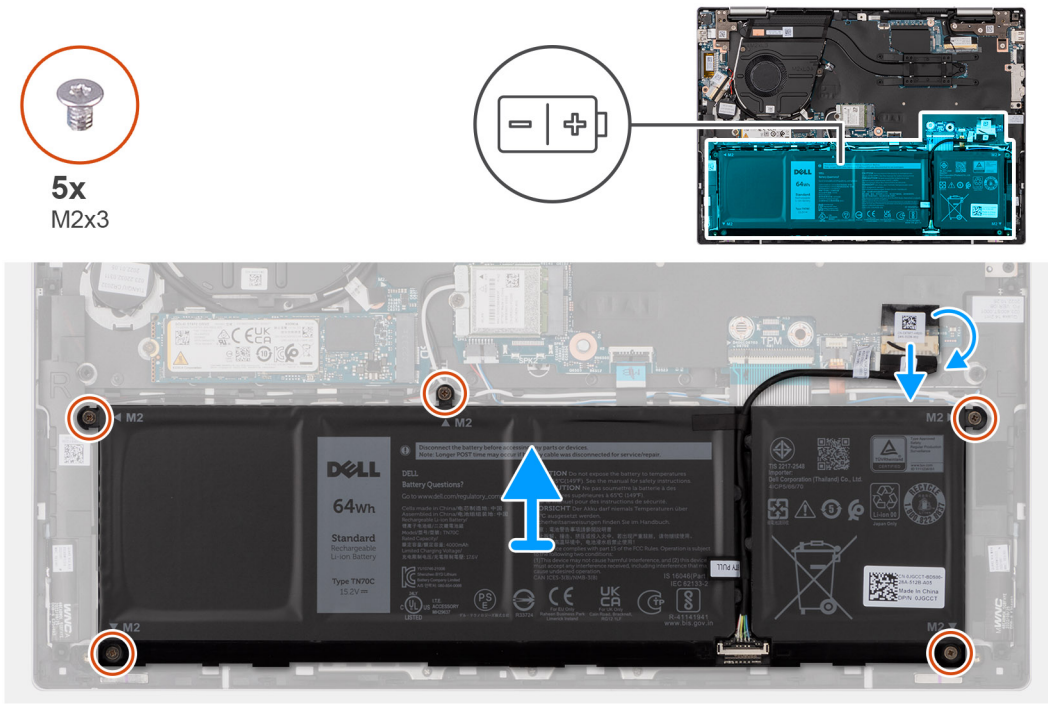

Steps

1. Peel the tape that secures the battery cable to the system board, if applicable.
2. Disconnect the battery cable from the system board, if applicable.
3. Remove the five screws (M2x3) that secure the battery to the palm-rest and keyboard assembly.
4. Lift the battery off the palm-rest and keyboard assembly.

Installing the battery

CAUTION: The information in this section is intended for authorized service technicians only.

Prerequisites

If you are replacing a component, remove the existing component before performing the installation process.

About this task

The following image indicates the location of the battery and provides a visual representation of the installation procedure.



5x
M2x3

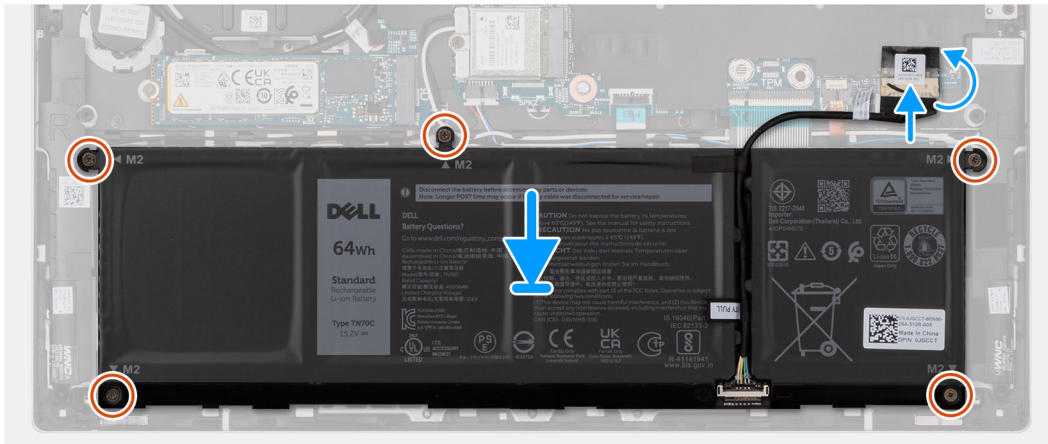
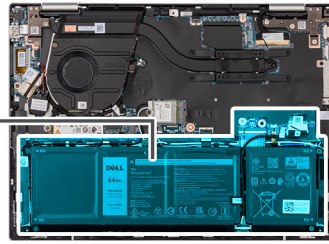
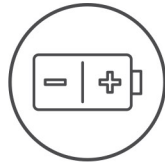

Steps

1. Align the screw holes on the battery with the screw holes on the palm-rest and keyboard assembly.
2. Replace the five screws (M2x3) that secure the battery to the palm-rest and keyboard assembly.
3. Connect the battery cable to the system board.
4. Adhere the tape that secures the battery cable to the system board.

Next steps

1. Install the [base cover](#).
2. Follow the procedure in [After working inside your computer](#).

Coin-cell battery

Removing the coin-cell battery

CAUTION: The information in this section is intended for authorized service technicians only.

Prerequisites

1. Follow the procedure in [Before working inside your computer](#).
2. Remove the [base cover](#).

About this task

The following image indicates the location of the coin-cell battery and provides a visual representation of the removal procedure.

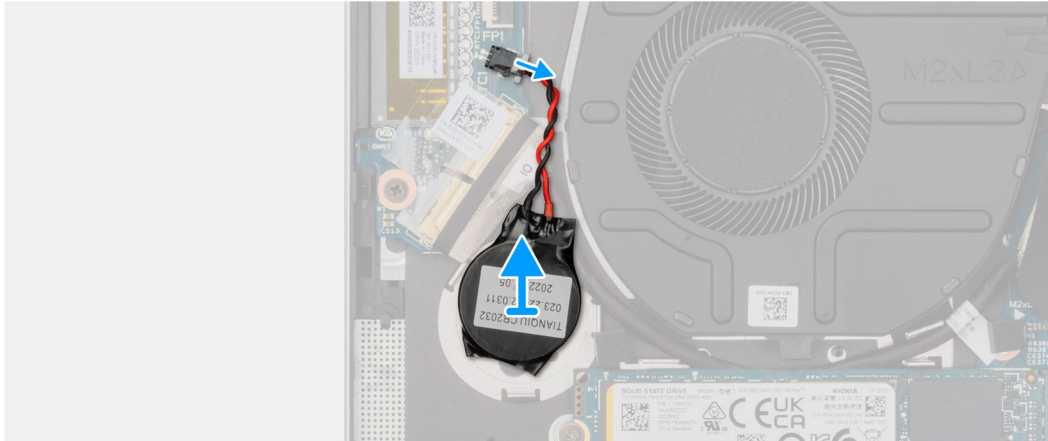
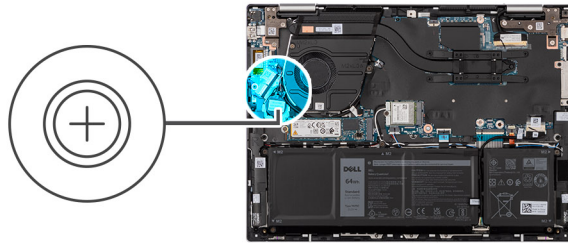

Steps

1. Disconnect the coin-cell battery from the I/O board.
2. Peel the coin-cell battery and lift it off the slot on the palm-rest and keyboard assembly.

Installing the coin-cell battery

CAUTION: The information in this section is intended for authorized service technicians only.

Prerequisites

If you are replacing a component, remove the existing component before performing the installation procedure.

About this task

The following image indicates the location of the coin-cell battery and provides a visual representation of the installation procedure.

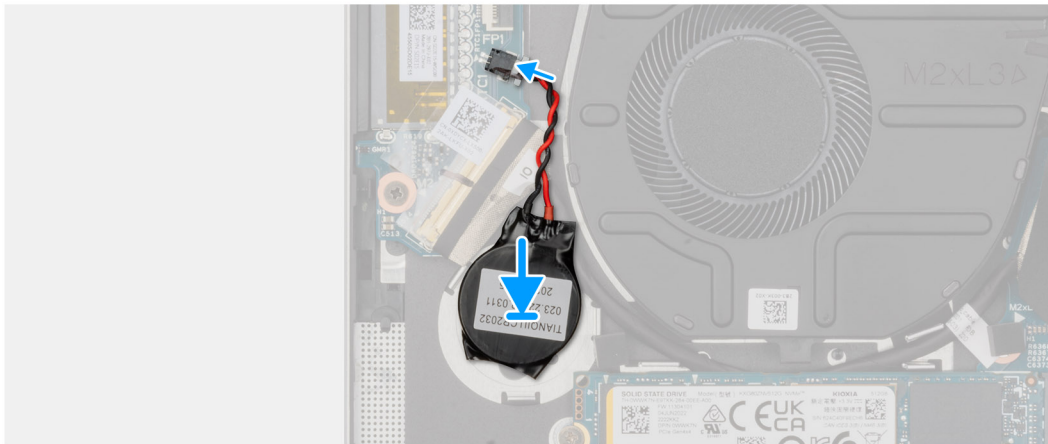
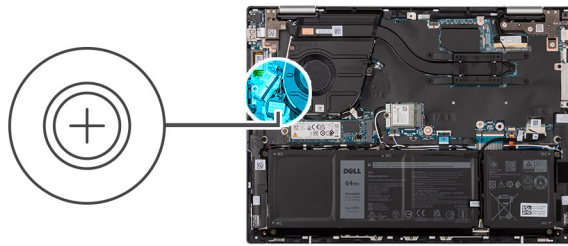

Steps

1. Adhere the coin-cell battery to the slot on the palm-rest and keyboard assembly.
2. Connect the coin-cell battery cable to the I/O board.

Next steps

1. Install the [base cover](#).
2. Follow the procedure in [After working inside your computer](#).

Heat sink

Removing the heat sink

Prerequisites

1. Follow the procedure in [Before working inside your computer](#).
2. Remove the [base cover](#).

About this task

NOTE: The heat sink may become hot during normal operation. Allow sufficient time for the heat sink to cool before you touch it.

NOTE: For maximum cooling of the processor, do not touch the heat transfer areas on the heat sink. The oils in your skin can reduce the heat transfer capability of the thermal grease.

The following image(s) indicate the location of the heat sink and provides a visual representation of the removal procedure.

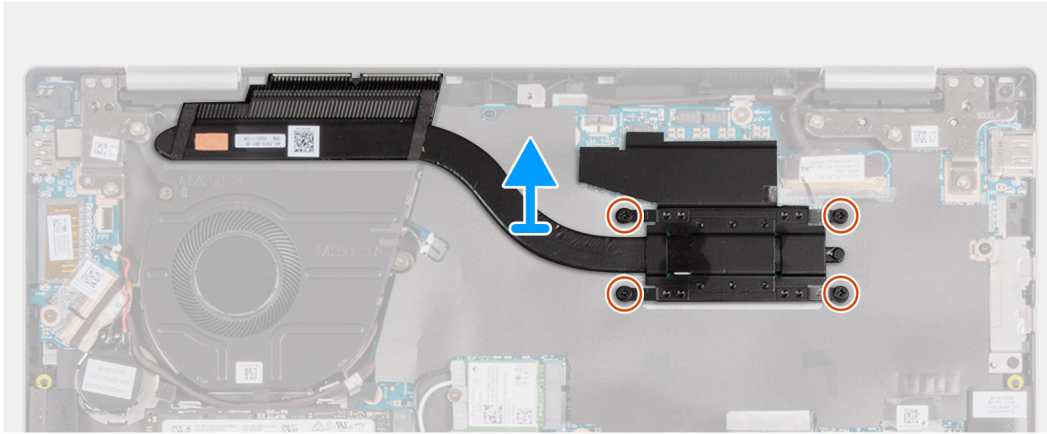
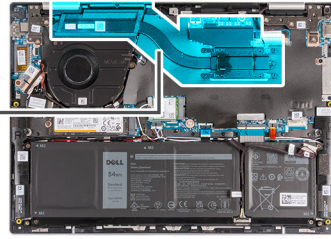
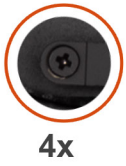

Steps

1. In reverse sequential order (4 > 3 > 2 > 1), loosen the four captive screws that secure the heat sink to the system board.
2. Lift the heat sink off the system board.

Installing the heat sink

Prerequisites

If you are replacing a component, remove the existing component before performing the installation process.

About this task

The following image(s) indicate the location of the heat sink and provides a visual representation of the installation procedure.



4x

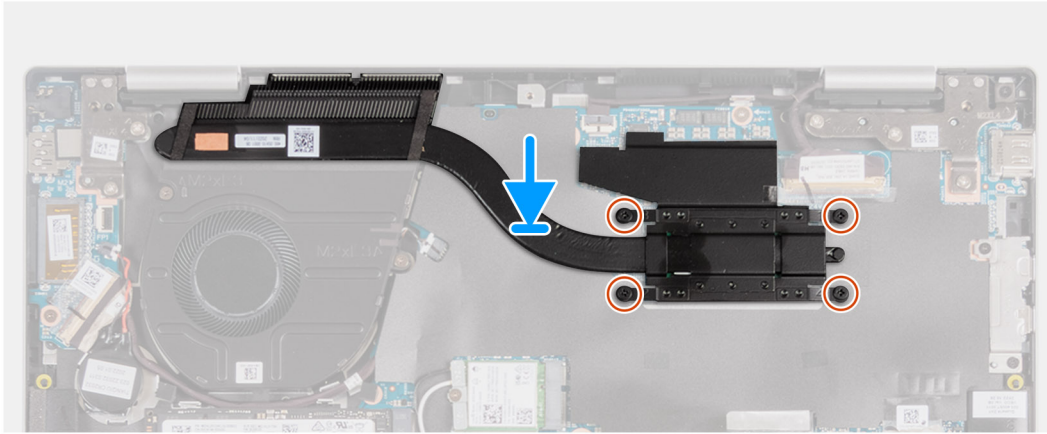
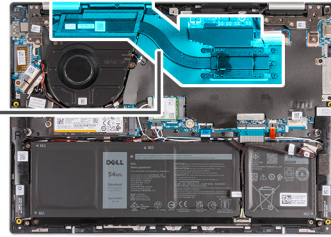

Steps

1. Place the heat sink on the system board.
2. Align the screw holes on the heat sink with the screw holes on the system board.
3. In sequential order (1 > 2 > 3 > 4) tighten the four captive screws that secure the heat sink to the system board.

Next steps

1. Install the [base cover](#).
2. Follow the procedure in [After working inside your computer](#).

I/O board

Removing the I/O board

 **CAUTION:** The information in this section is intended for authorized service technicians only.

Prerequisites

1. Follow the procedure in [Before working inside your computer](#).
2. Remove the [base cover](#).

About this task

The following image(s) indicate the location of the I/O board and provides a visual representation of the removal procedure.

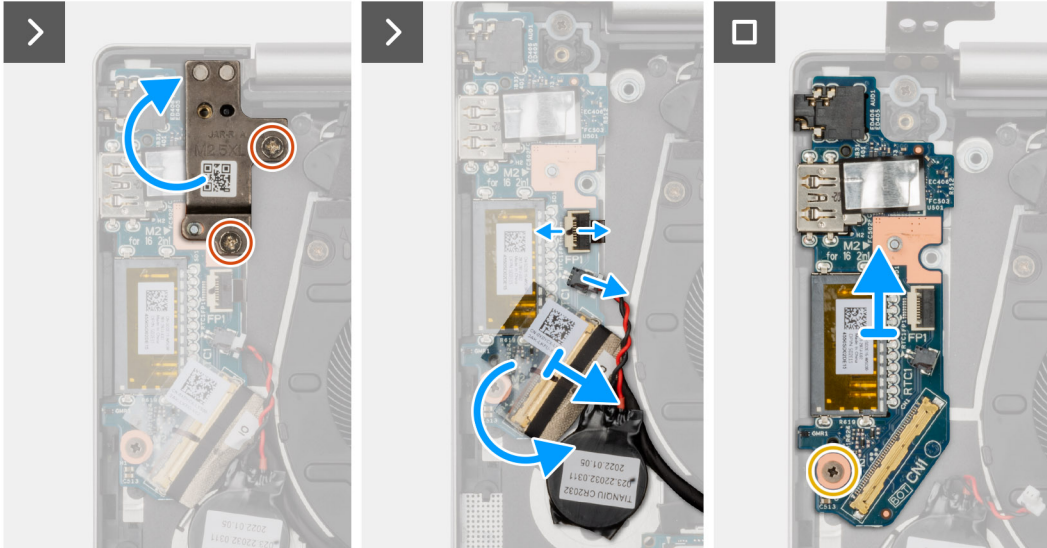
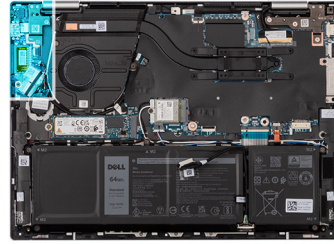

Steps

1. Remove the two screws (M2.5x4) that secure the left display hinge to the palm-rest and keyboard assembly.
2. Pry open the left display hinge to an angle of 90 degrees.
3. Lift the latch and disconnect the power-button with fingerprint reader cable from the I/O board.
 - NOTE:** This step is only applicable to computers shipped with the optional fingerprint reader.
4. Disconnect the coin-cell battery cable from the I/O board.
5. Peel the tape that secures the I/O-board connector latch to the I/O board.
6. Lift the I/O-board cable-connector latch and disconnect the I/O-board cable from the I/O board.
7. Remove the screw (M2x3) that secure the I/O board to the palm-rest and keyboard assembly.
8. Lift the I/O board off the palm-rest and keyboard assembly.

Installing the I/O board

CAUTION: The information in this section is intended for authorized service technicians only.

Prerequisites

If you are replacing a component, remove the existing component before performing the installation process.

About this task

The following image(s) indicate the location of the I/O board and provides a visual representation of the installation procedure.

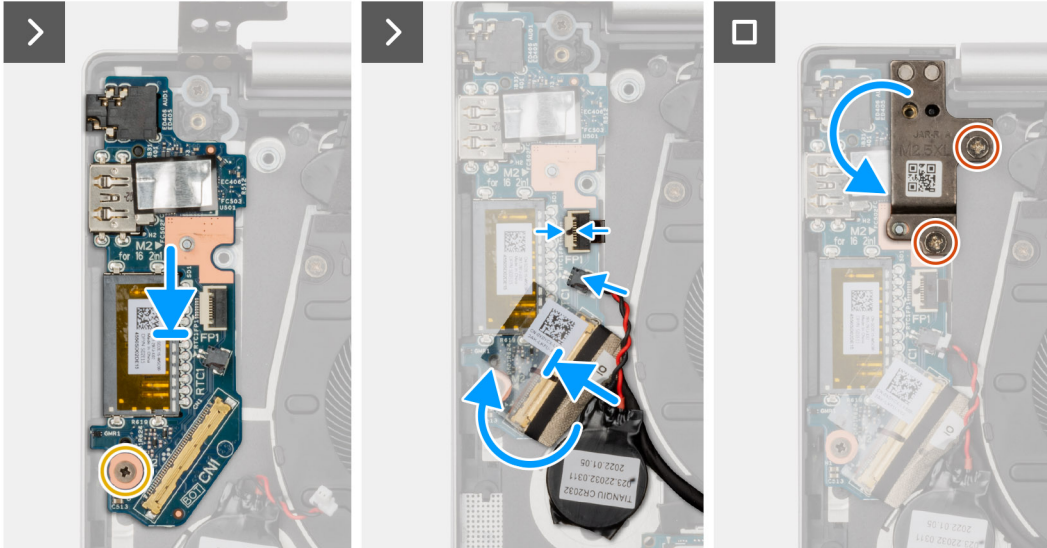
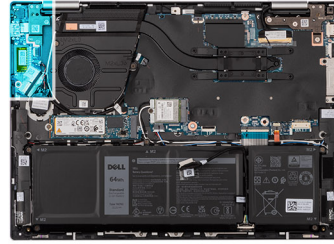

Steps

1. Place the I/O board on the palm-rest and keyboard assembly.
2. Align the screw holes on the I/O board with the screw holes on the palm-rest and keyboard assembly.
3. Replace the screw (M2x3) that secure the I/O board to the palm-rest and keyboard assembly.
4. Connect the I/O-board cable to the connector on the I/O board and close the latch.
5. Adhere the tape over the screw on the I/O board.
6. Connect the coin-cell battery to the connector on the I/O board.
7. Connect the power-button with fingerprint-reader cable to the connector on the I/O board and close the latch.

i **NOTE:** This step is only applicable to computers shipped with the optional fingerprint reader.

8. Close the left display hinge and align the screw holes on the left display hinge with the screw holes on the I/O board.
9. Replace the two screws (M2.5x4) that secure the left display hinge to the palm-rest and keyboard assembly.

Next steps

1. Install the [base cover](#).
2. Follow the procedure in [After working inside your computer](#).

Power-button

Removing the power-button

⚠ CAUTION: The information in this section is intended for authorized service technicians only.

Prerequisites

1. Follow the procedure in [Before working inside your computer](#).

2. Remove the [base cover](#).
3. Remove the [I/O board](#).

About this task

NOTE: This procedure is applicable only for computers that are shipped without the optional fingerprint reader.

The following image indicates the location of the power-button and provides a visual representation of the removal procedure.

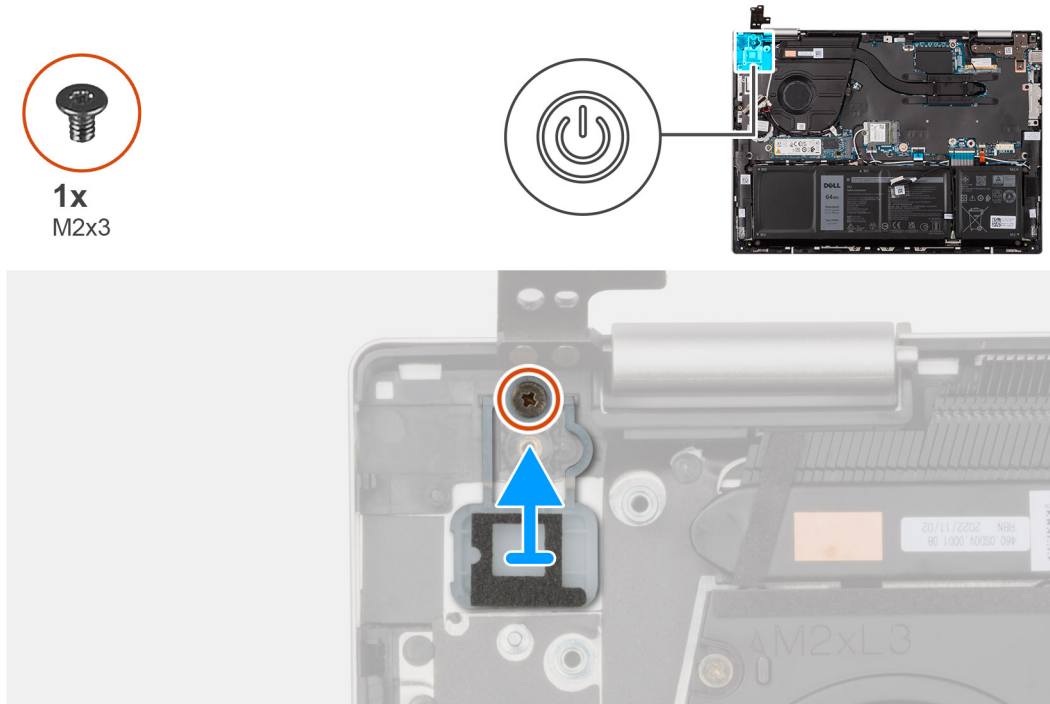

Steps

1. Remove the screw (M2x3) that secures the power-button to the palm-rest and keyboard assembly.
2. Lift the power-button off the palm-rest and keyboard assembly.

Installing the power-button

CAUTION: The information in this section is intended for authorized service technicians only.

Prerequisites

If you are replacing a component, remove the existing component before performing the installation procedure.

About this task

NOTE: This procedure is applicable only when you are installing a power-button without the optional fingerprint reader.

The following image indicates the location of the power-button and provides a visual representation of the installation procedure.



1x
M2x3

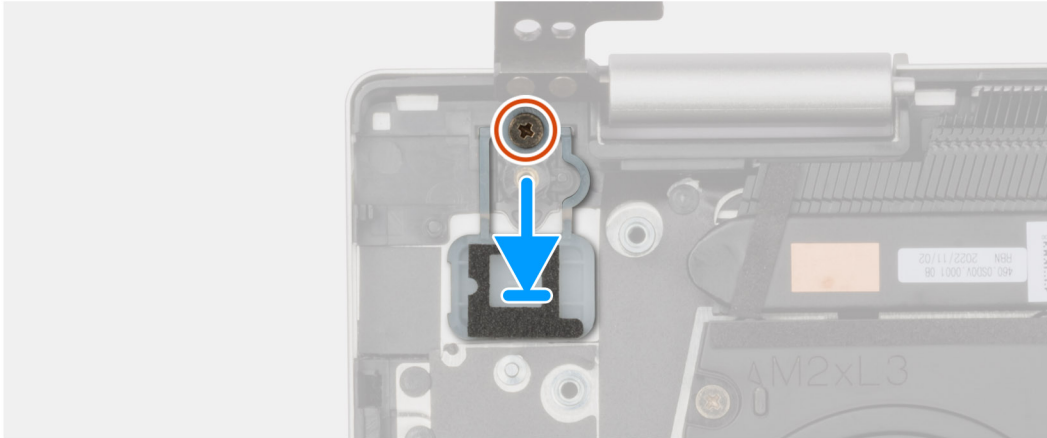
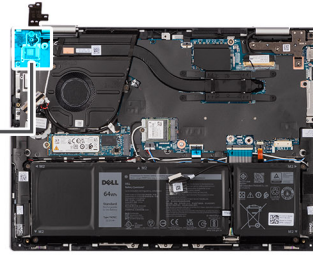

Steps

1. Place the power-button into its slot on the palm-rest and keyboard assembly.
2. Align the screw hole on the power-button with the screw hole on the palm-rest and keyboard assembly.
3. Replace the screw (M2x3) that secures power-button to the palm-rest and keyboard assembly.

Next steps

1. Install the [I/O board](#).
2. Install the [base cover](#).
3. Follow the procedure in [After working inside your computer](#).

Removing the power-button with fingerprint reader

CAUTION: The information in this section is intended for authorized service technicians only.

Prerequisites

1. Follow the procedure in [Before working inside your computer](#).
2. Remove the [base cover](#).
3. Remove the [I/O board](#).

About this task

NOTE: This procedure is applicable only for computers that are shipped with a fingerprint reader on the power-button.

The following images indicate the location of the power-button with fingerprint reader and provides a visual representation of the removal procedure.



1x
M2x3

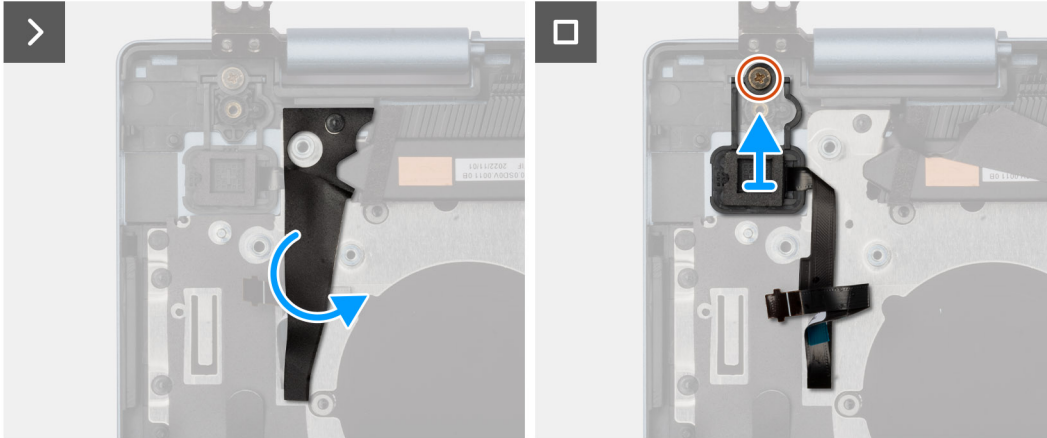
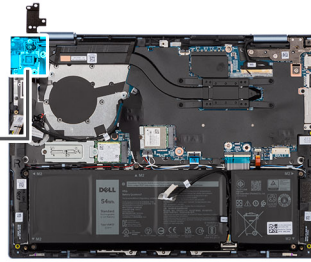

Steps

1. Peel off the mylar covering the fingerprint-reader cable.
2. Remove the screw (M2x3) that secures the power-button with fingerprint reader to the palm-rest and keyboard assembly.
3. Lift the power-button with fingerprint reader, along with the fingerprint-reader cable, off the palm-rest and keyboard assembly.

Installing the power-button with fingerprint reader

CAUTION: The information in this section is intended for authorized service technicians only.

Prerequisites

If you are replacing a component, remove the existing component before performing the installation procedure.

About this task

NOTE: This procedure is applicable only when you are installing a power-button with fingerprint reader into your computer.

The following image indicates the location of the power-button with fingerprint reader and provides a visual representation of the installation procedure.



1x
M2x3

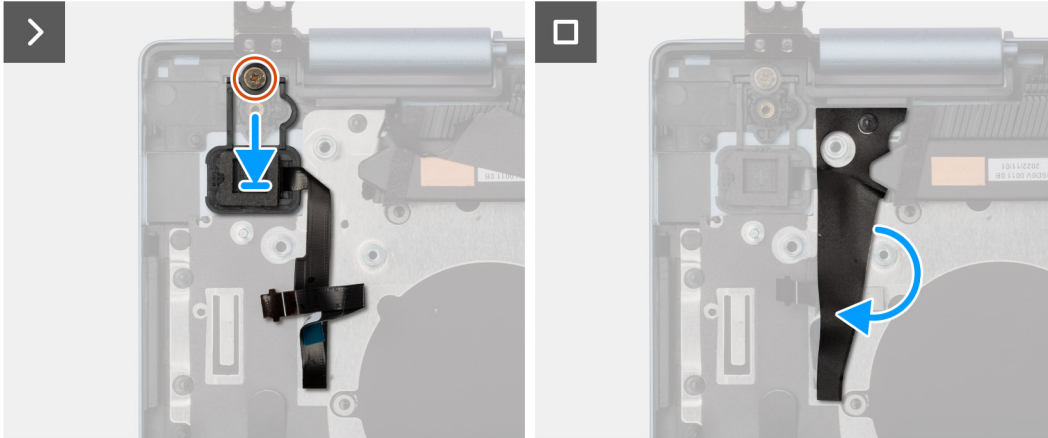
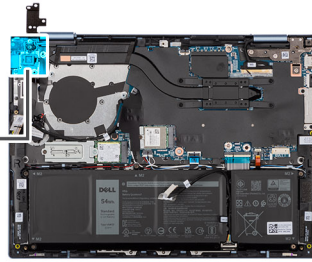

Steps

1. Align and place the power-button, along with the fingerprint-reader cable, into its slot on the palm-rest and keyboard assembly.
2. Align the screw hole on the power-button with the screw holes on the palm-rest and keyboard assembly.
3. Replace the screw (M2x3) that secures power-button to the palm-rest and keyboard assembly.
4. Adhere the mylar over the fingerprint-reader cable, securing it to the palm-rest and keyboard assembly.

Next steps

1. Install the [I/O board](#).
2. Install the [base cover](#).
3. Follow the procedure in [After working inside your computer](#).

Touchpad

Removing the touchpad

 **CAUTION:** The information in this section is intended for authorized service technicians only.

Prerequisites

1. Follow the procedure in [Before working inside your computer](#).
2. Remove the [base cover](#).
3. Remove the [battery](#).

About this task

The following images indicate the location of the touchpad and provides a visual representation of the removal procedure.

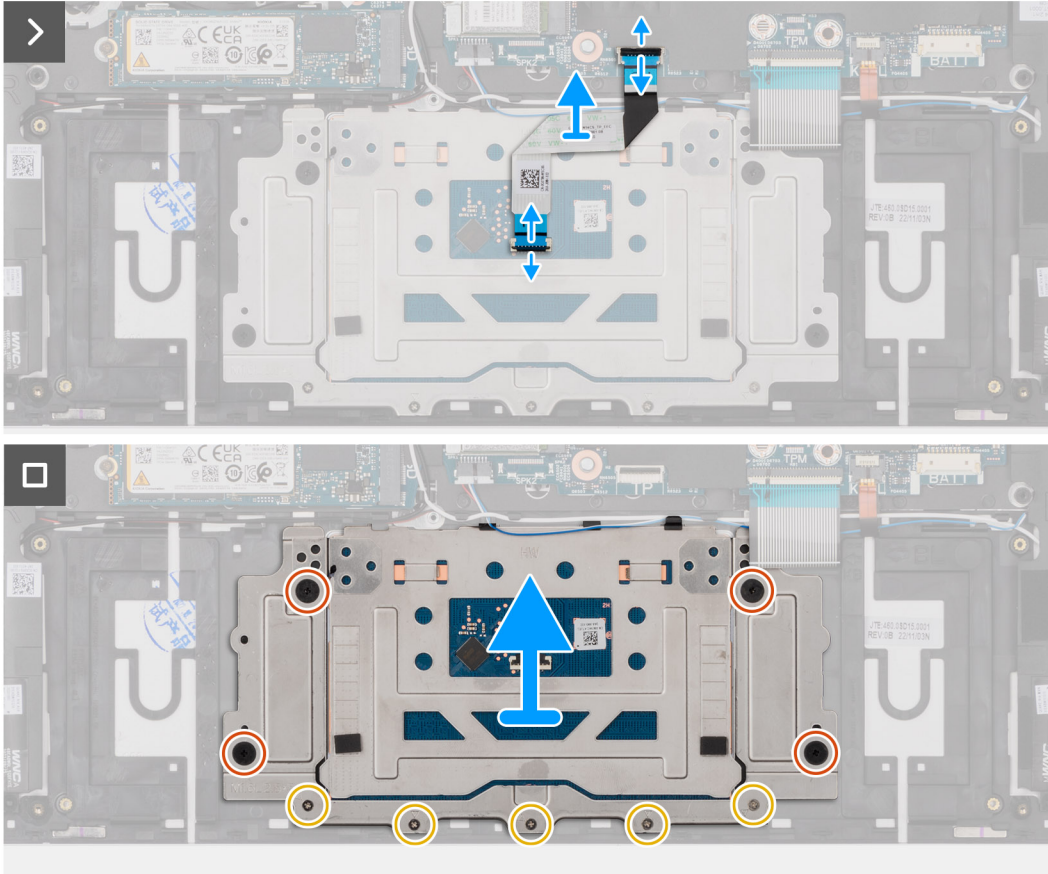
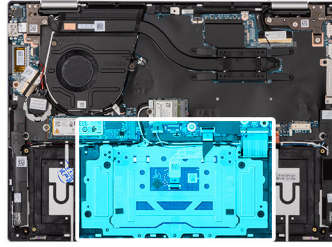

Steps

1. Lift the latch and disconnect the touchpad cable from the system board.
2. Lift the latch and disconnect the touchpad cable from the touchpad.
3. Lift the touchpad cable off the palm-rest and keyboard assembly.
4. Remove the five screws (M1.6x2.5) and the four screws (M2x2) that secure the touchpad to the palm-rest and keyboard assembly.
5. Lift the touchpad off the palm-rest and keyboard assembly.

Installing the touchpad

CAUTION: The information in this section is intended for authorized service technicians only.

Prerequisites

If you are replacing a component, remove the existing component before performing the installation process.

About this task

The following images indicate the location of the touchpad and provides a visual representation of the installation procedure.

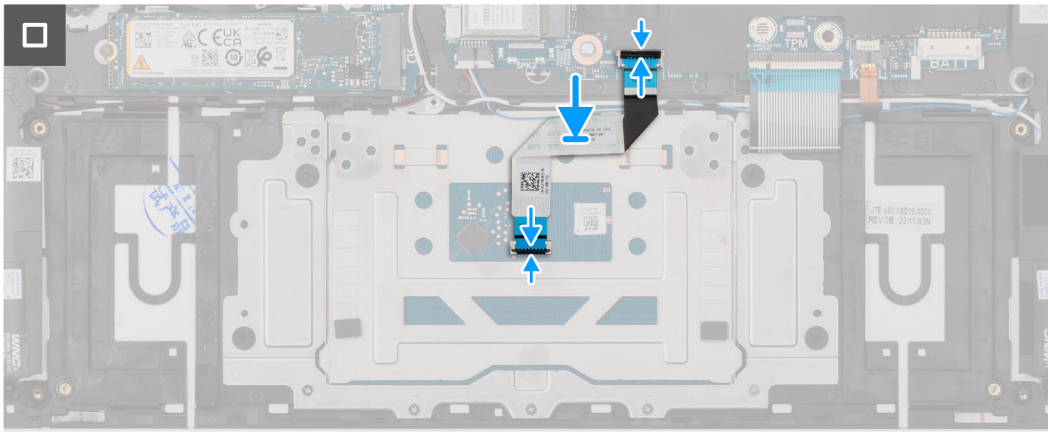
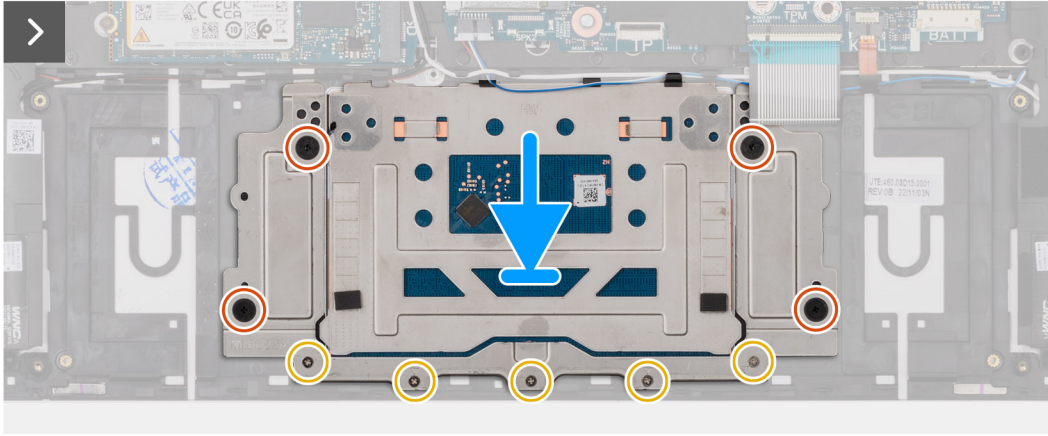
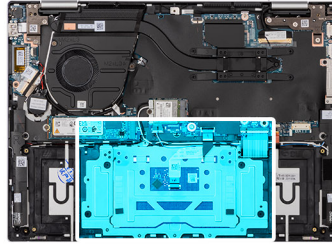

Steps

1. Place the touchpad into its slot on the palm-rest and keyboard assembly.
2. Align the screw holes on the touchpad with the screw holes on the palm-rest and keyboard assembly.
3. Replace the four screws (M2x2) and the five screws (M1.6x2.5) that secure the touchpad to the palm-rest and keyboard assembly.
4. Place the touchpad cable on the palm-rest and keyboard assembly.
5. Connect the touchpad cable to the touchpad and close the latch.
6. Connect the touchpad cable to the system board and close the latch.

Next steps

1. Install the [battery](#).
2. Install the [base cover](#).
3. Follow the procedure in [After working inside your computer](#).

Speakers

Removing the speakers

CAUTION: The information in this section is intended for authorized service technicians only.

Prerequisites

1. Follow the procedure in [Before working inside your computer](#).
2. Remove the [base cover](#).
3. Remove the [battery](#).
4. Remove the [wireless card](#).

About this task

The following image indicates the location of the speakers and provides a visual representation of the removal procedure.

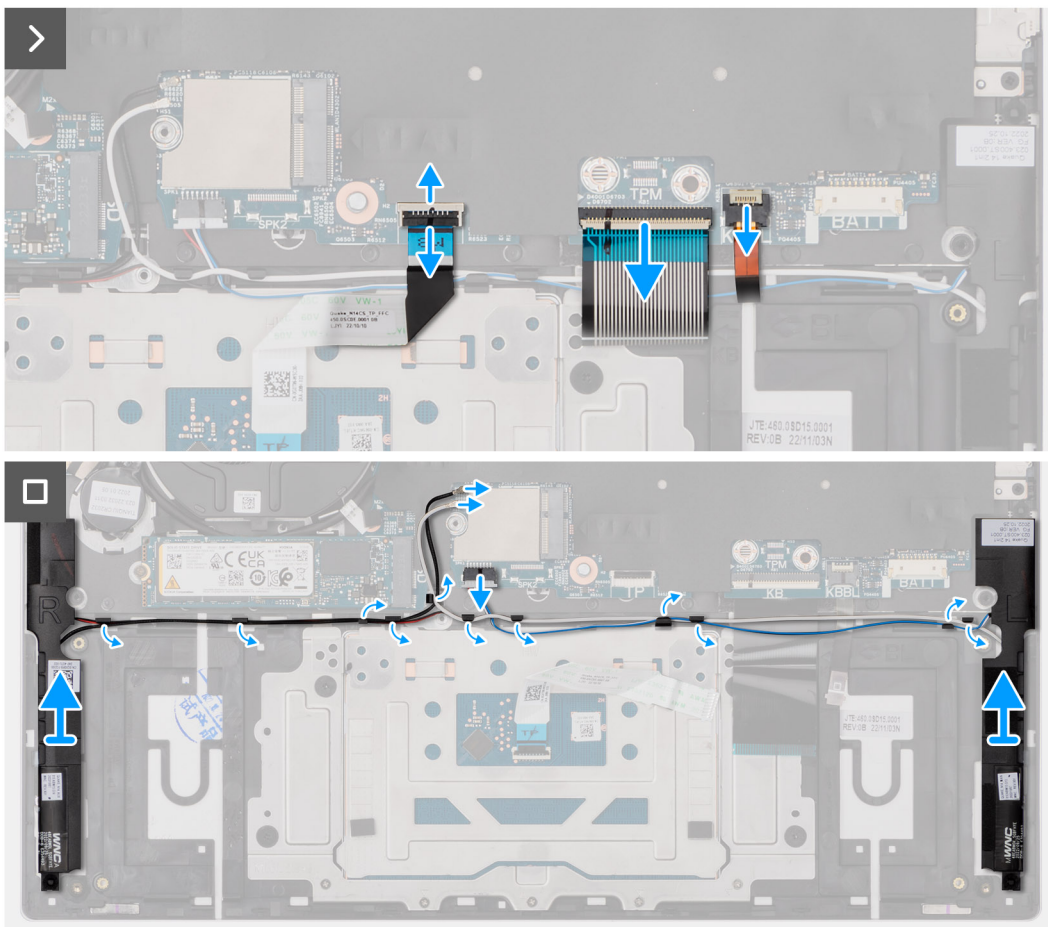
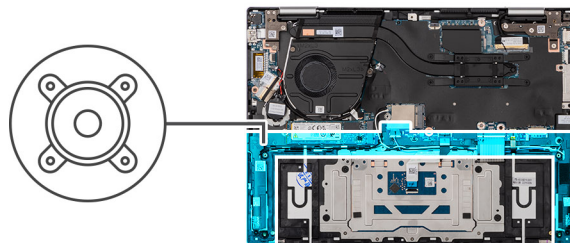

Steps

1. Lift the latch and disconnect the keyboard-backlight cable from the system board.
2. Lift the latch and disconnect the keyboard cable from the system board.
3. Lift the latch and disconnect the touchpad cable from the system board.
4. Disconnect the speaker cable from the connector on the system board.
5. Remove the speaker and wireless module cables and from the routing guides on the palm-rest and keyboard assembly.
6. Lift the left and right speakers along with the cables, off the palm-rest and keyboard assembly.

Installing the speakers

 **CAUTION:** The information in this section is intended for authorized service technicians only.

Prerequisites

If you are replacing a component, remove the existing component before performing the installation procedure.

About this task

The following image indicates the location of the speakers and provides a visual representation of the installation procedure.

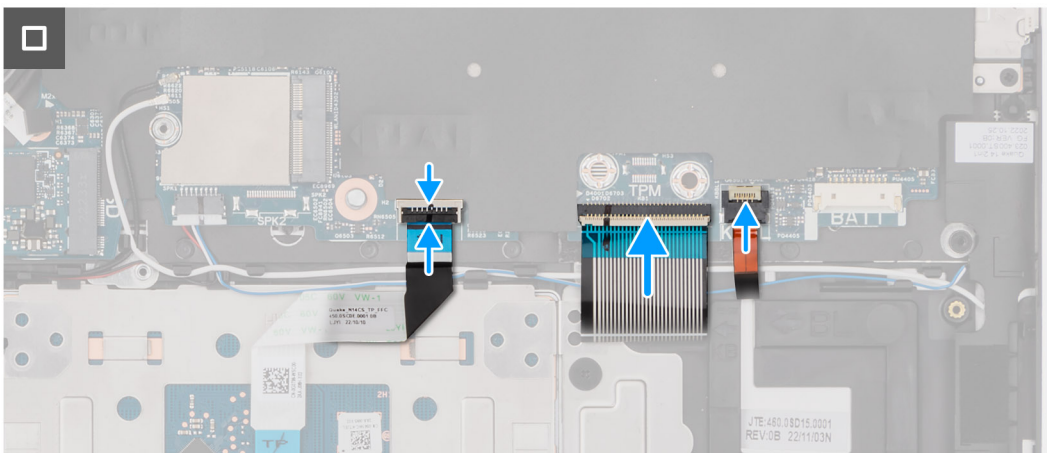
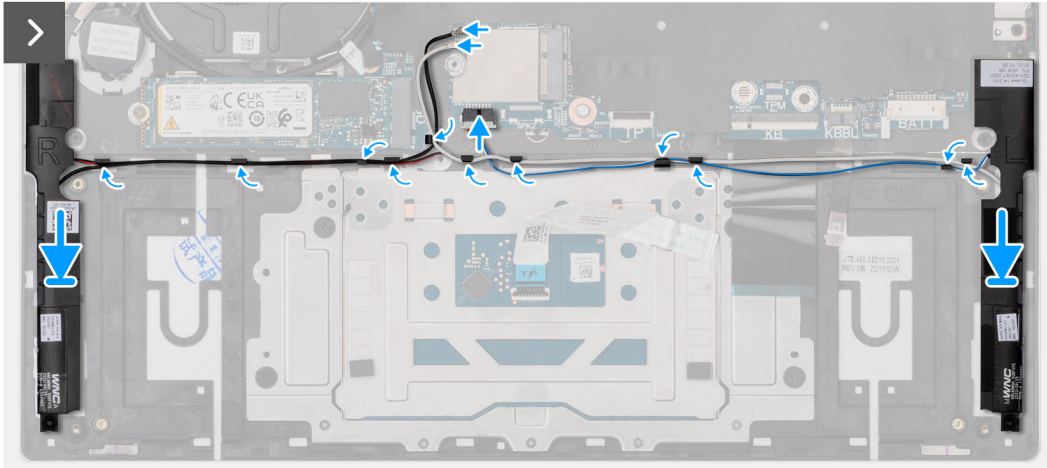
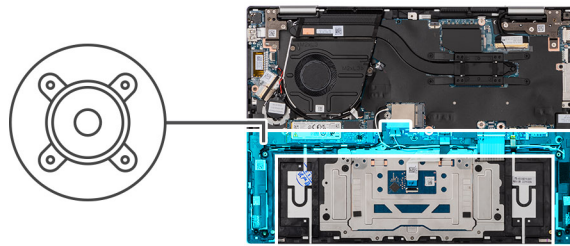

Steps

1. Using the alignment posts and rubber grommets, place the speakers on the slots of the palm-rest and keyboard assembly.
2. Route the speaker and wireless module cables through the routing guides on the palm-rest and keyboard assembly.
3. Connect the speaker cable to the system board.
4. Connect the touchpad cable to the system board and close the latch.
5. Connect the keyboard cable to the system board and close the latch.
6. Connect the keyboard-backlight cable to the system board and close the latch.

Next steps

1. Install the [wireless card](#).
2. Install the [battery](#).
3. Install the [base cover](#).
4. Follow the procedure in [After working inside your computer](#).

Display assembly

Removing the display assembly

CAUTION: The information in this section is intended for authorized service technicians only.

Prerequisites

1. Follow the procedure in [Before working inside your computer](#).
2. Remove the [base cover](#).

About this task

The following image(s) indicate the location of the display assembly and provides a visual representation of the removal procedure.

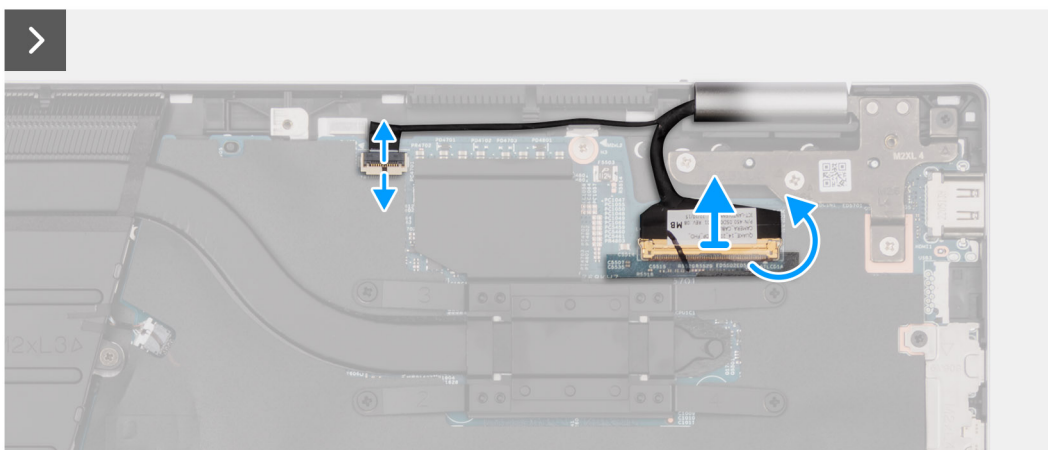
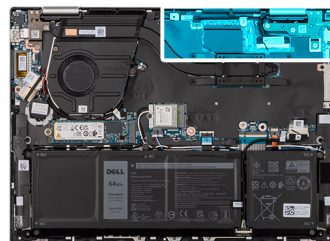



5x
M2.5x4



1x
M2x4



Steps

1. Peel the tape that secures the display-cable connector latch to the system board.
2. Lift the latch and disconnect the display cable from the connector on the system board.
3. Lift the latch and disconnect the touch-screen cable from the connector on the system board.
4. Open the display and place the computer on a clean and flat surface.
5. Remove the two screws (M2.5x4) that secure the left display hinge to the palm-rest and keyboard assembly.
6. Remove the three screws (M2.5x4) and the screw (M2x4) that secure the right display hinge to the palm-rest and keyboard assembly.
7. Gently lift the display assembly off the palm-rest and keyboard assembly.

Installing the display assembly

CAUTION: The information in this section is intended for authorized service technicians only.

Prerequisites

If you are replacing a component, remove the existing component before performing the installation process.

About this task

The following image(s) indicate the location of the display assembly and provides a visual representation of the installation procedure.



5x
M2.5x4



1x
M2x4

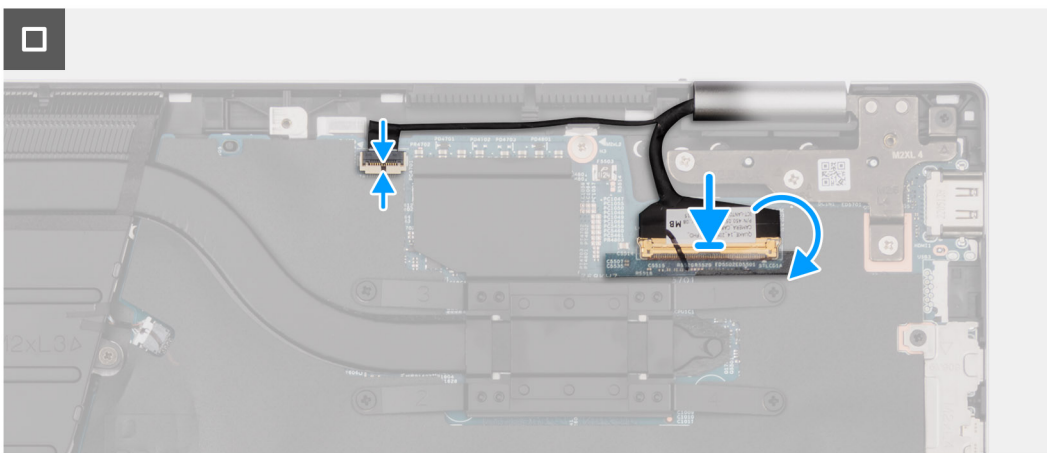
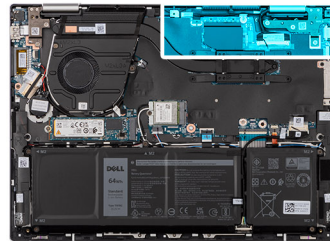

Steps

1. Place the palm-rest and keyboard assembly on a clean and flat surface.

2. Place the display assembly on the palm-rest and keyboard assembly.

CAUTION: To avoid damaging the display, do not slide the display assembly.

3. Align the screw holes on the left display hinge with the screw holes on the palm-rest and keyboard assembly.
4. Replace the two screws (M2.5x4) that secure the left display hinge to the palm-rest and keyboard assembly.
5. Align the screw holes on the right display hinge with the screw holes on the system board.
6. Replace the three screws (M2.5x4) and the screw (M2x4) that secure the right display hinge to the palm-rest and keyboard assembly.
7. Close the display lid and place the computer on a clean and flat surface.
8. Connect the touch-screen cable to the connector on the system board and close the latch.
9. Connect the display cable to the connector on the system board and close the latch.
10. Adhere the tape that secures the display-cable connector latch to the system board.

Next steps

1. Install the [base cover](#).
2. Follow the procedure in [After working inside your computer](#).

System board

Removing the system board

Prerequisites

1. Follow the procedure in [Before working inside your computer](#).
2. Remove the [base cover](#).
3. Remove the [battery](#).
4. Remove the [M.2 2230 solid-state drive](#) or the [M.2 2280 solid-state drive](#), whichever is applicable.
5. Remove the [wireless card](#).
6. Remove the [display assembly](#).
7. Remove the [fan](#).
8. Remove the [heat sink](#).

About this task

The following image indicates the connectors on your system board.

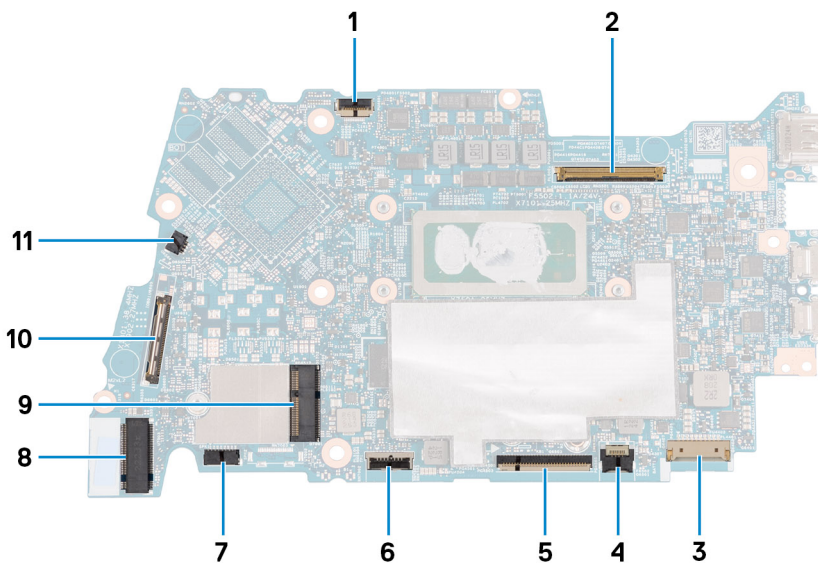

1. Display-board cable connector

2. Display-cable connector
3. Battery-cable connector
4. Keyboard-backlight cable connector
5. Keyboard-cable connector
6. Touchpad-cable connector
7. Speaker-cable connector
8. M.2 solid-state drive connector
9. M.2 wireless-card connector
10. I/O-board cable connector
11. Fan-cable connector

The following image(s) indicate the location of the system board and provides a visual representation of the removal procedure.



3x
M2.5x4



3x
M2x4



2x
M2x1.8

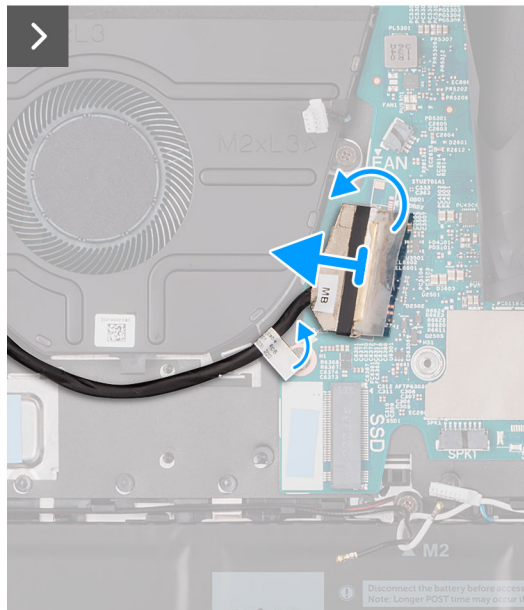
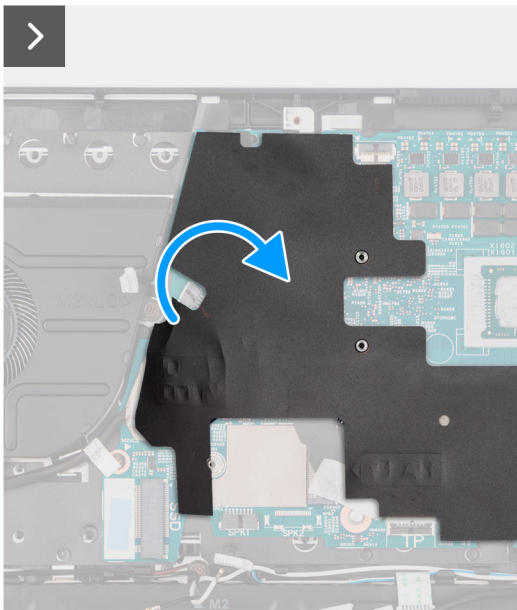
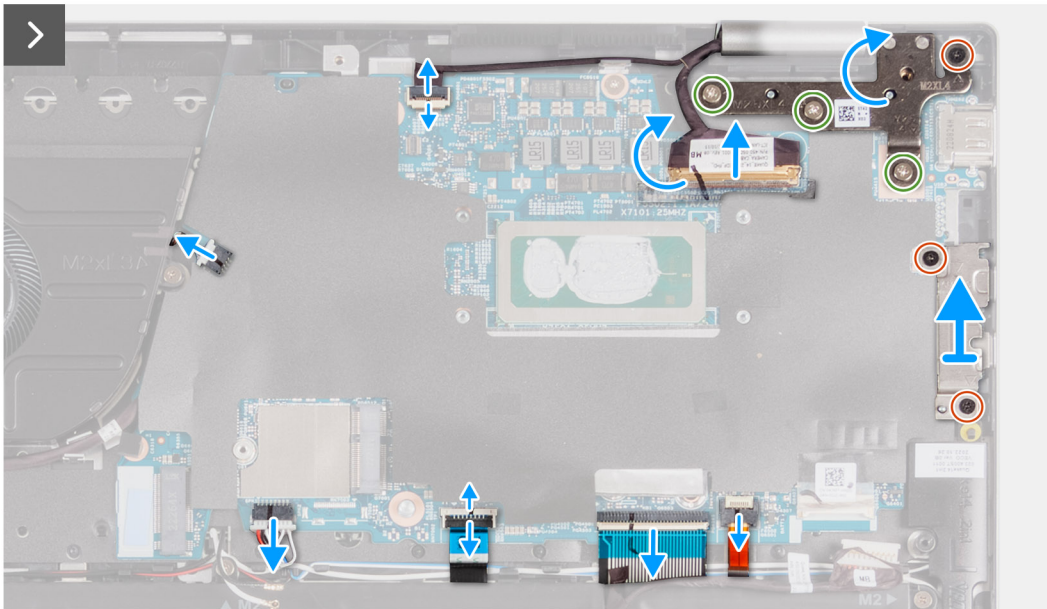
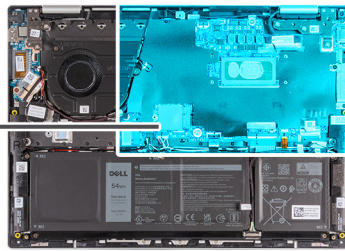

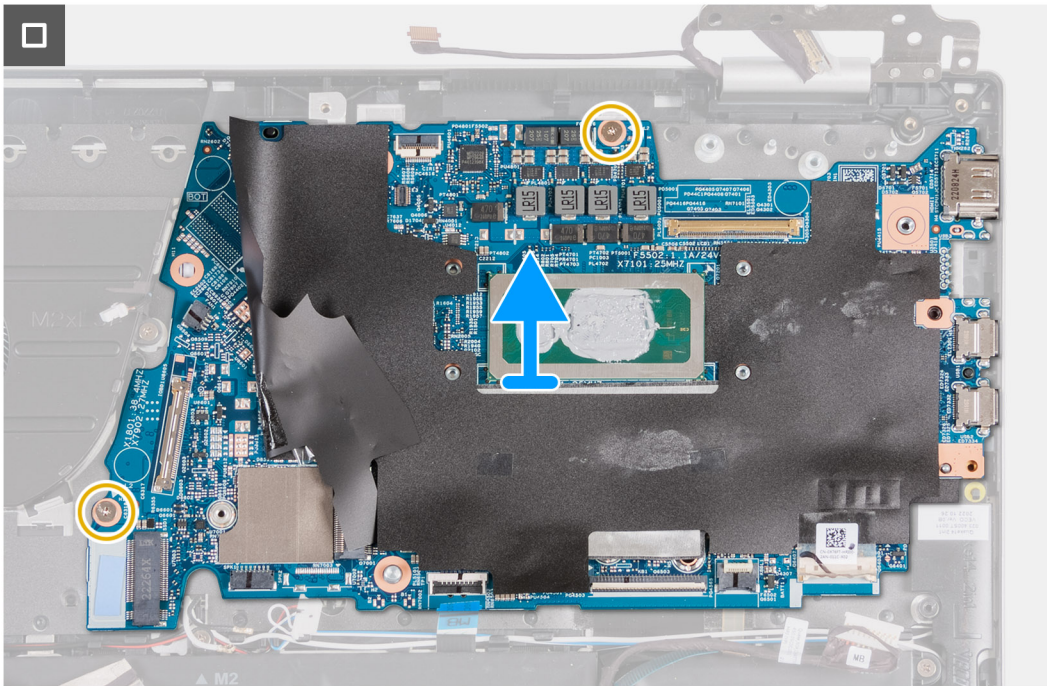

Steps

1. Peel the tape that secures the I/O-board connector latch to the system board.
2. Lift the latch and disconnect the I/O-board cable from the system board.
3. Disconnect the fan cable from the system board.
4. Disconnect the speaker cable from the speaker board.
5. Lift the latch and disconnect the touchpad cable from the system board.
6. Lift the latch and disconnect the keyboard cable from the system board.
7. Lift the latch and disconnect the keyboard-backlight cable from the system board.
8. Remove the two screws (M2x4) that secure the USB Type-C bracket to the system board.
9. Lift the USB Type-C bracket off the system board.
10. Remove the two screws (M2x2) that secure the system board to the palm-rest and keyboard assembly.
11. Lift the system board off the palm-rest and keyboard assembly.

Installing the system board

Prerequisites

If you are replacing a component, remove the existing component before performing the installation process.

About this task

The following image indicates the connectors on your system board.

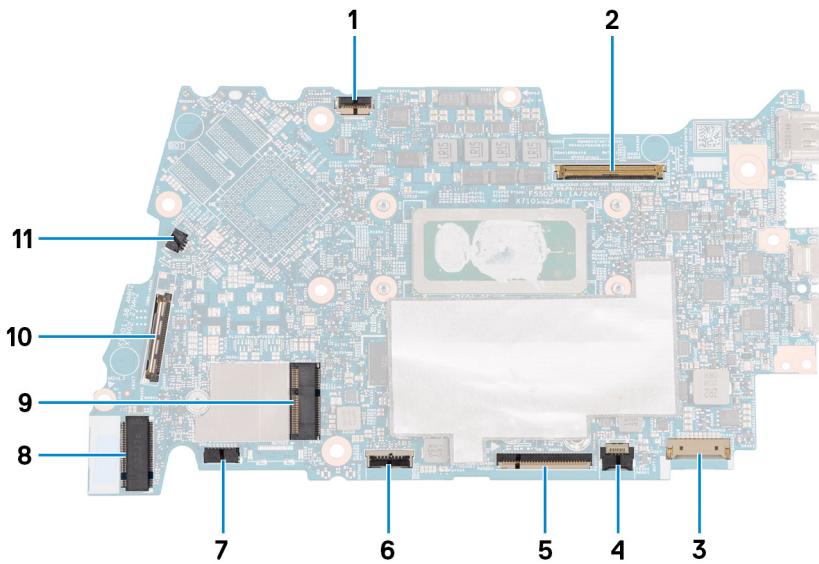

1. Display-board cable connector
2. Display-cable connector
3. Battery-cable connector
4. Keyboard-backlight cable connector
5. Keyboard-cable connector
6. Touchpad-cable connector
7. Speaker-board cable connector
8. Speaker-cable connector
9. M.2 solid-state drive connector
10. M.2 wireless-card connector
11. IO-board cable connector
12. Fan-cable connector

The following image(s) indicate the location of the system board and provides a visual representation of the installation procedure.



3x
M2.5x4



3x
M2x4



2x
M2x1.8

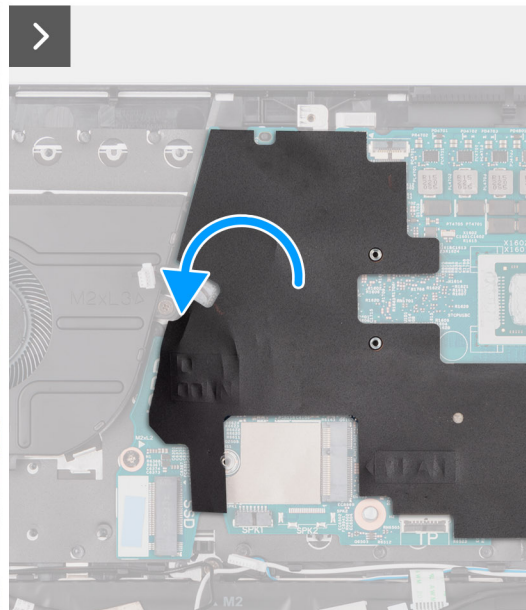
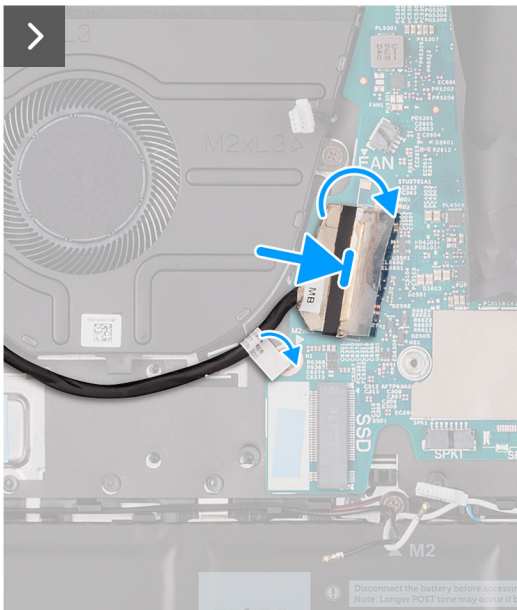
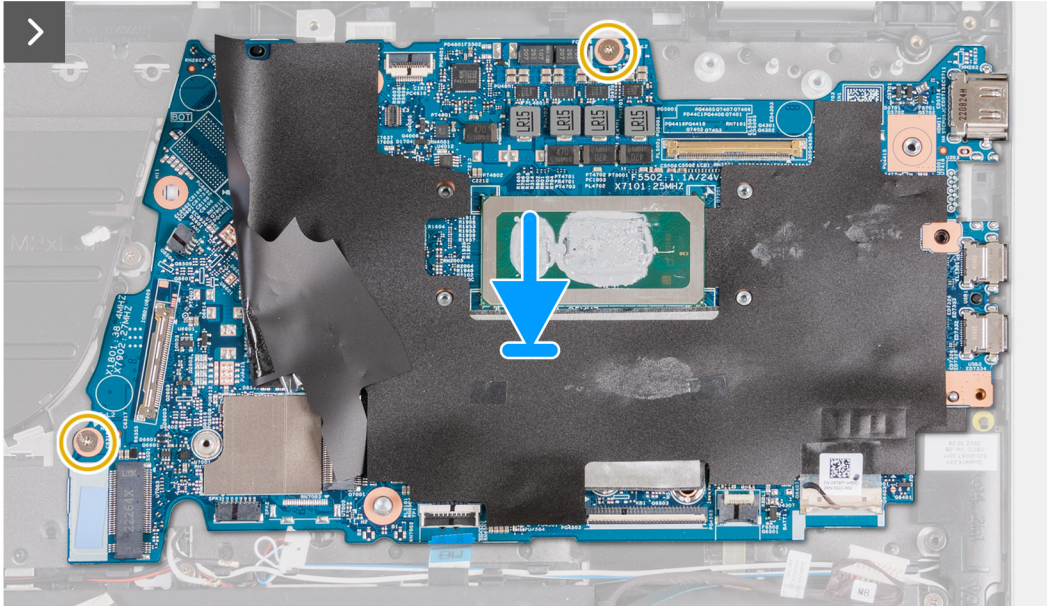
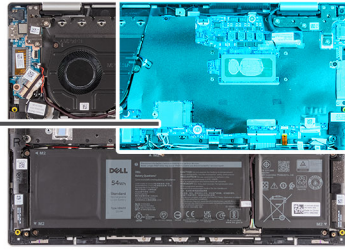
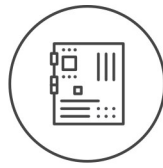

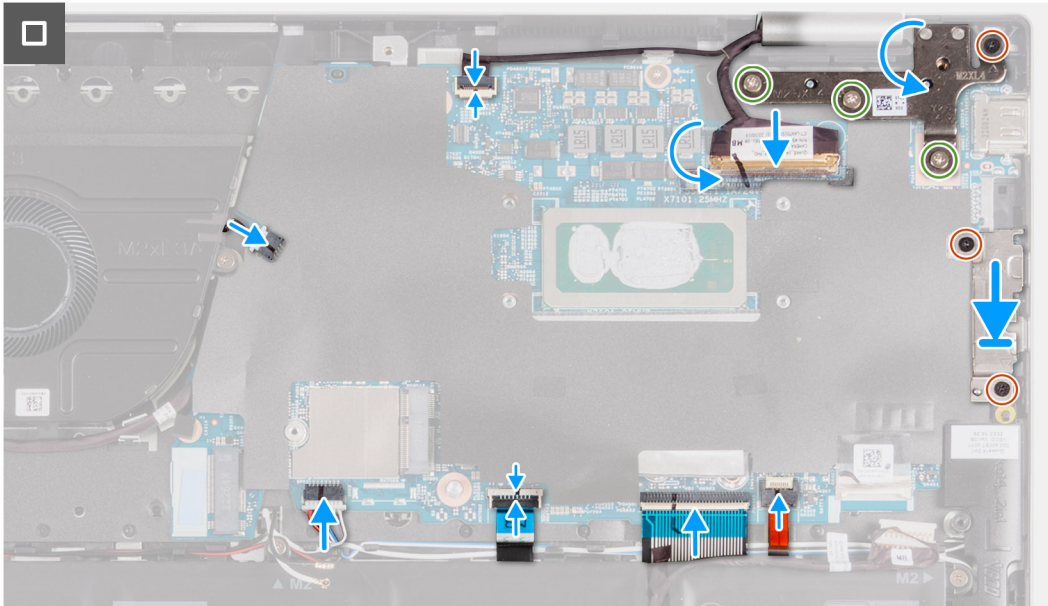

Steps

1. Align the screw holes on the system board with the screw holes on the palm-rest and keyboard assembly.
2. Replace the two screws (M2x2) that secure the system board to the palm-rest and keyboard assembly.
3. Connect the fan cable to the connector on the system board.
4. Connect the I/O cable to the connector on the system board.
5. Connect the speaker cable to the connector on the speaker board.
6. Connect the touchpad cable to the system board and close the latch.
7. Connect the keyboard cable to the system board and close the latch.
8. Connect the keyboard-backlight cable to the system board and close the latch.
9. Place the USB Type-C bracket on the system board.
10. Align the screw holes on the USB Type-C bracket to the screw holes on the system board.
11. Replace the two screws (M2x4) that secure the USB Type-C bracket to the system board.

Next steps

1. Install the [heat sink](#).
2. Install the [fan](#).
3. Install the [display assembly](#).
4. Install the [wireless card](#).
5. Install the [M.2 2230 solid-state drive](#) or [M.2 2280 solid-state drive](#), whichever is applicable.
6. Install the [battery](#).
7. Install the [base cover](#).
8. Follow the procedure in [After working inside your computer](#).

Palm-rest and keyboard assembly

Removing the palm-rest and keyboard assembly

CAUTION: The information in this section is intended for authorized service technicians only.

Prerequisites

1. Follow the procedure in [Before working inside your computer](#).
2. Remove the [base cover](#).

3. Remove the [battery](#).
4. Remove the [coin-cell battery](#).
5. Remove the [wireless card](#).
6. Remove the [M.2 2230 solid-state drive](#) or the [M.2 2280 solid-state drive](#), whichever is applicable.
7. Remove the [I/O board](#).
8. Remove the [speakers](#).
9. Remove the [fan](#).
10. Remove the [power button](#) or the [power button with fingerprint reader](#).
11. Remove the [display assembly](#).
12. Remove the [system board](#).

NOTE: The system board can be removed with the heat sink attached to avoid breaking the thermal bond between the heat sink and the system board.

13. Remove the [touchpad](#).

About this task

The following image indicates the location of the palm-rest and keyboard assembly and provides a visual representation of the removal procedure.

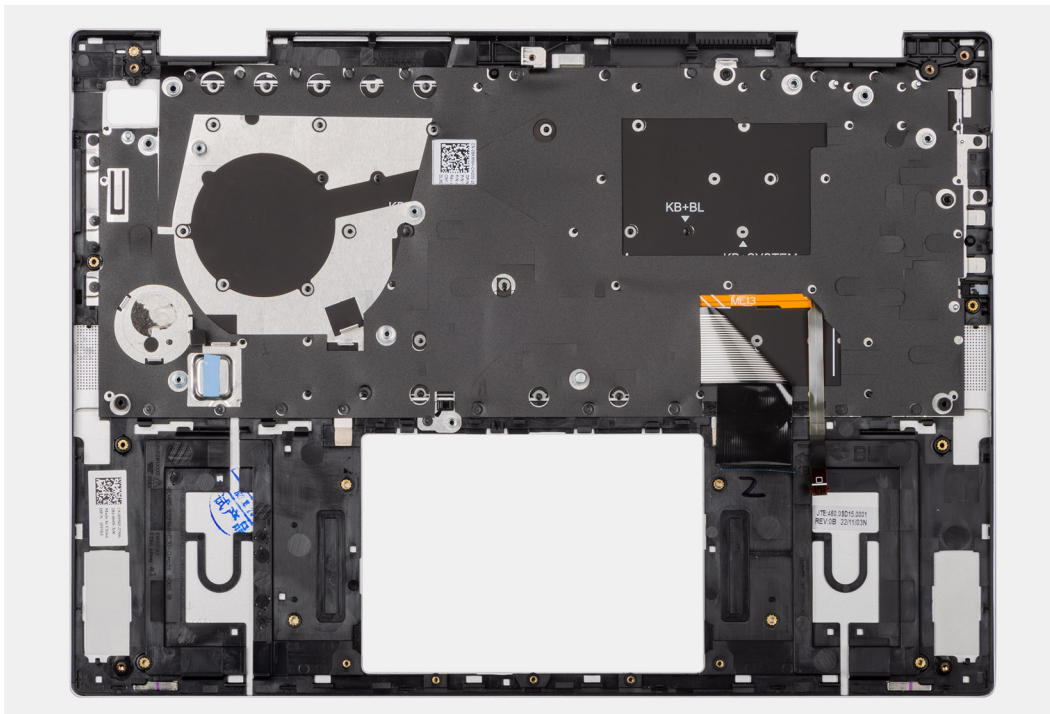

Steps

After performing the steps in the pre-requisites, you are left with the palm-rest and keyboard assembly.

Installing the palm-rest and keyboard assembly

CAUTION: The information in this section is intended for authorized service technicians only.

Prerequisites

If you are replacing a component, remove the existing component before performing the installation procedure.

About this task

The following image indicates the location of the palm-rest and keyboard assembly and provides a visual representation of the installation procedure.

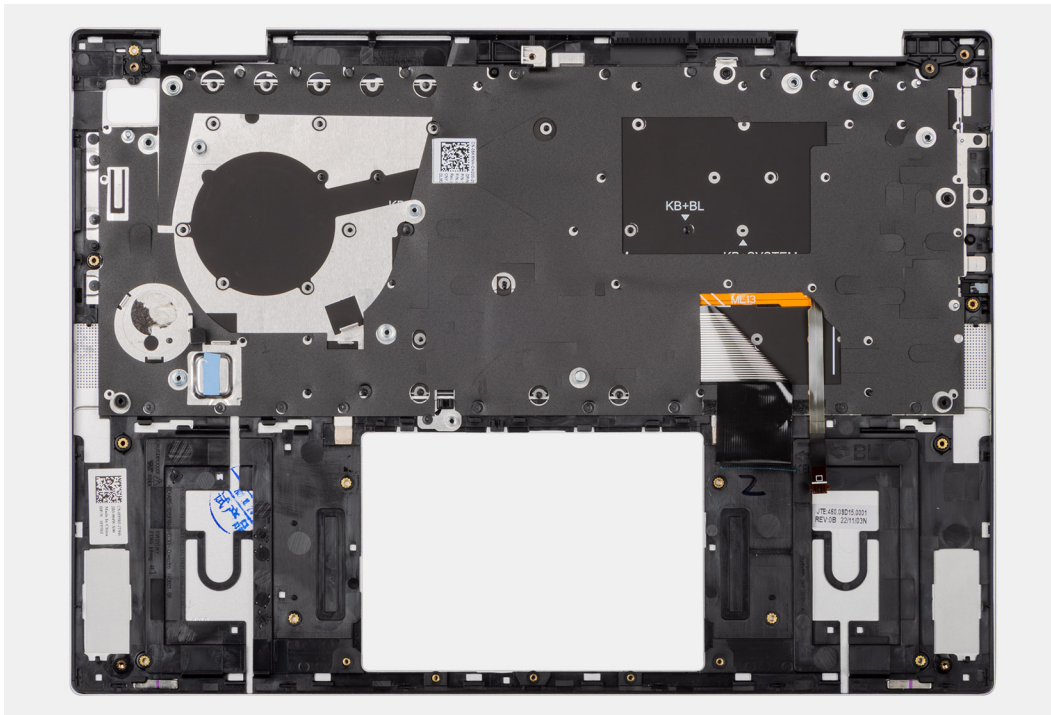

Steps

Place the palm-rest and keyboard assembly on a clean and flat surface.

Next steps

1. Install the [touchpad](#).
2. Install the [system board](#).
i NOTE: The system board can be removed with the heat sink attached to avoid breaking the thermal bond between the heat sink and the system board.
3. Install the [display assembly](#).
4. Install the [power button](#) or the [power button with fingerprint reader](#), whichever is applicable..
5. Install the [fan](#).
6. Install the [speakers](#).
7. Install the [I/O board](#).
8. Install the [M.2 2230 solid-state drive](#) or the [M.2 2280 solid-state drive](#), whichever is applicable.
9. Install the [wireless card](#).
10. Install the [coin-cell battery](#).
11. Install the [battery](#).
12. Install the [base cover](#).
13. Follow the procedure in [After working inside your computer](#).

Software

This chapter details the supported operating systems along with instructions on how to install the drivers.

Operating system

Your Inspiron 14 7430 2-in-1 supports the following operating systems:

- Windows 11 Pro, 64-bit
- Windows 11 Pro National Education, 64-bit
- Windows 11 Home, 64-bit
- Windows 11 Home in S-mode, 32-bit

Drivers and downloads

When troubleshooting, downloading or installing drivers it is recommended that you read the Dell Knowledge Based article, Drivers and Downloads FAQ [000123347](#).

BIOS setup

CAUTION: Unless you are an expert computer user, do not change the settings in the BIOS Setup program. Certain changes can make your computer work incorrectly.

NOTE: Depending on the computer and its installed devices, the items listed in this section may or may not be displayed.

NOTE: Before you change BIOS Setup program, it is recommended that you write down the BIOS Setup program screen information for future reference.

Use the BIOS Setup program for the following purposes:

- Get information about the hardware installed in your computer, such as the amount of RAM and the size of the hard drive.
- Change the system configuration information.
- Set or change a user-selectable option, such as the user password, type of hard drive installed, and enabling or disabling base devices.

Entering BIOS setup program

About this task

Turn on (or restart) your computer and press F2 immediately.

Navigation keys

NOTE: For most of the System Setup options, changes that you make are recorded but do not take effect until you restart the system.

Table 26. Navigation keys

Keys	Navigation
Up arrow	Moves to the previous field.
Down arrow	Moves to the next field.
Enter	Selects a value in the selected field (if applicable) or follow the link in the field.
Spacebar	Expands or collapses a drop-down list, if applicable.
Tab	Moves to the next focus area. NOTE: For the standard graphics browser only.
Esc	Moves to the previous page until you view the main screen. Pressing Esc in the main screen displays a message that prompts you to save any unsaved changes and restarts the system.

One time boot menu

To enter **one time boot menu**, turn on your computer, and then press F12 immediately.

NOTE: It is recommended to shutdown the computer if it is on.

The one-time boot menu displays the devices that you can boot from including the diagnostic option. The boot menu options are:

- HDD1- Windows Boot Manager
- BIOS Setup
- Diagnostics
 - **i** **NOTE:** Choosing **Diagnostics**, will display the **ePSA diagnostics** screen.
- SupportAssist OS Recovery
- BIOS Flash Update

The boot sequence screen also displays the option to access the System Setup screen.

System setup options

i **NOTE:** Depending on your system and its installed devices, the items that are listed in this section may or may not appear.

Table 27. System setup options—System information menu

Overview	
Inspiron 14 7430 2-in-1	
BIOS Version	Displays the BIOS version number.
Service Tag	Displays the Service Tag of the system.
Asset Tag	Displays the Asset Tag of the system.
Manufacture Date	Displays the manufacture date of the system.
Ownership Date	Displays the ownership date of the system.
Express Service Code	Displays the express service code of the system.
Ownership Tag	Displays the Ownership Tag of the system.
Signed Firmware Update	Displays whether the Signed Firmware Update is enabled on your system.
Battery	
Primary	Displays that battery is primary.
Battery Level	Displays the battery level of the system.
Battery State	Displays the battery state of the system.
Health	Displays the battery health of the system.
AC Adapter	Displays whether the AC adapter is connected or not.
Processor	
Processor Type	Displays the processor type.
Maximum Clock Speed	Displays the maximum processor clock speed.
Minimum Clock Speed	Displays the minimum processor clock speed.
Current Clock Speed	Displays the current processor clock speed.
Core Count	Displays the number of cores on the processor.
Processor ID	Displays the processor identification code.
Processor L2 Cache	Displays the processor L2 Cache size.
Processor L3 Cache	Displays the processor L3 Cache size.
Microcode Version	Displays the microcode version.
Intel Hyper-Threading Capable	Displays whether the processor is Hyper-Threading (HT) capable.
64-Bit Technology	Displays whether 64-bit technology is used.

Table 27. System setup options—System information menu (continued)

Overview	
Memory	
Memory Installed	Displays the total system memory installed.
Memory Available	Displays the total system memory available.
Memory Speed	Displays the memory speed.
Memory Channel Mode	Displays single or dual channel mode.
Memory Technology	Displays the technology that is used for the memory.
Devices Information	
Panel Type	Displays the Panel Type of the system.
Video Controller	Displays the video controller type of the system.
Video Memory	Displays the video memory information of the system.
Wi-Fi Device	Displays the wireless device information of the system.
Native Resolution	Displays the native resolution of the system.
Video BIOS Version	Displays the video BIOS version of the system.
Audio Controller	Displays the audio controller information of the system.
Bluetooth Device	Displays the Bluetooth device information of the system.
dGPU Video Controller	Displays the discrete graphics processor model.

Table 28. System setup options—Boot Configuration menu

Boot Configuration	
Boot Sequence	
Boot Mode: UEFI only	Displays the boot mode.
Boot Sequence	Displays the boot sequence.
Secure Boot	
Enable Secure Boot	Enable or disable the secure boot feature. By default, the option is not enabled.
Enable Microsoft UEFI CA	Enable or disable Microsoft UEFI CA (Certificate Authority) to include the UEFI CA in the NIOS UEFI Secure Boot DB database. By default, the option is enabled.
Secure Boot Mode	Enable or disable to change the secure boot mode options. By default, the Deployed Mode is enabled.

Table 29. System setup options—Integrated Devices menu

Integrated Devices	
Date/Time	Displays the current date in MM/DD/YYYY format and current time in HH:MM:SS AM/PM format.
Camera	Enables or disable the camera. By default, the Enable Camera option is selected
Audio	
Enable Audio	Enable or disable the integrated audio controller. By default, all the options are enabled.

Table 30. System setup options—Storage menu

Storage	
Storage interface	
Port Enablement	This page allows you to enable the onboard drives. By default, the M.2 PCIe SSD option is enabled.
Drive Information	
M.2 PCIe SSD	
Type	Displays the M.2 PCIe SSD type information of the system.
Device	Displays the M.2 PCIe SSD device information of the system.

Table 31. System setup options—Display menu

Display	
Display Brightness	
Brightness on battery power	Enable to set screen brightness when the system is running on battery power.
Brightness on AC power	Enable to set screen brightness when the system is running on AC power.

Table 32. System setup options—Connection menu

Connection	
HTTP(s) Boot Feature	
HTTP(s) Boot	Enable or disable the HTTP(s) Boot feature. By default, the HTTPs Boot option is disabled.
HTTP(s) Boot Modes	Select the HTTP(s) boot mode. By default, the Auto Mode option is disabled.

Table 33. System setup options—Passwords menu

Passwords	
Admin Password	Set, change, or delete the administrator password.
M.2 PCIe SSD-0	Set, change, or delete the NVMe SSD0 password.

Table 34. System setup options—Update, Recovery menu

Update, Recovery	
SupportAssist OS Recovery	Enable or disable the boot flow for SupportAssist OS Recovery tool in the event of certain system errors. By default, the option is enabled.
BIOSConnect	Enable or disable cloud Service operating system recovery if the main operating system fails to boot with the number of failures equal to or greater than the value specified by the Auto operating system Recovery Threshold setup option and local Service operating system does not boot or is not installed. By default, the option is enabled.
Dell Auto operating system Recovery Threshold	Controls the automatic boot flow for SupportAssist System Resolution Console and for Dell operating system Recovery Tool. By default, the threshold value is set to 2.

Table 35. System setup options—System Management menu

System Management	
Service Tag	Displays the Service Tag of the system.
Asset Tag	Create a system Asset Tag.
First Power On Date	
Set Ownership Date	Enable to set the ownership date. By default, the option is disabled.
Diagnostics	
OS Agent Requests	Enable to set the system to schedule onboard diagnostics on a subsequent boot which can help assist in the prevention and resolution of hardware-related issues. By default, the option is enabled.

Table 36. System setup options—Keyboard menu

Keyboard	
Keyboard Illumination	Set the keyboard illumination settings. By default, the option Bright is enabled.
Keyboard Backlight Timeout on AC	Set the timeout value for the keyboard backlight when an AC adapter is plugged into the system. By default, the option 1 minute is enabled.
Keyboard Backlight Timeout on Battery	Set the timeout value for the keyboard backlight when the system is running on battery power only. By default, the option 1 minute is enabled.

Table 37. System setup options—Pre-boot Behavior menu

Pre-boot Behavior	
Adapter Warnings	
Enable Adapter Warnings	Enable or disable the warning messages during boot when the adapters with less power capacity are detected. By default, the option is enabled.
Warning and Errors	Enable or disable the action to be done when a warning or error is encountered. By default, the Prompt on Warnings and Errors option is enabled.
USB-C Warnings	
Enable Dock Warning Messages	By default, the option is enabled.

Table 38. System setup options—System Logs menu

System Logs	
BIOS Event Log	
Clear BIOS Event Log	Displays BIOS events. By default, the Keep Log option is enabled.
Thermal Event Log	
Clear Thermal Event Log	Displays Thermal events. By default, the Keep Log option is enabled.

Table 38. System setup options—System Logs menu (continued)

System Logs	
Power Event Log	
Clear Power Event Log	Displays power events. By default, the Keep Log option is enabled.
License Information	Displays the license information of the system.

Updating the BIOS

Updating the BIOS in Windows

Steps

1. Go to www.dell.com/support.
2. Click **Product support**. In the **Search support** box, enter the Service Tag of your computer, and then click **Search**.
 **NOTE:** If you do not have the Service Tag, use the SupportAssist feature to automatically identify your computer. You can also use the product ID or manually browse for your computer model.
3. Click **Drivers & Downloads**. Expand **Find drivers**.
4. Select the operating system installed on your computer.
5. In the **Category** drop-down list, select **BIOS**.
6. Select the latest version of BIOS, and click **Download** to download the BIOS file for your computer.
7. After the download is complete, browse the folder where you saved the BIOS update file.
8. Double-click the BIOS update file icon and follow the on-screen instructions.
For more information, see knowledge base article [000124211](https://www.dell.com/support/000124211) at www.dell.com/support.

Updating the BIOS using the USB drive in Windows

Steps

1. Follow the procedure from step 1 to step 6 in [Updating the BIOS in Windows](#) to download the latest BIOS setup program file.
2. Create a bootable USB drive. For more information, see the knowledge base article [000145519](https://www.dell.com/support/000145519) at www.dell.com/support.
3. Copy the BIOS setup program file to the bootable USB drive.
4. Connect the bootable USB drive to the computer that needs the BIOS update.
5. Restart the computer and press **F12**.
6. Select the USB drive from the **One Time Boot Menu**.
7. Type the BIOS setup program filename and press **Enter**.
The **BIOS Update Utility** appears.
8. Follow the on-screen instructions to complete the BIOS update.

Updating the BIOS from the F12 One-Time boot menu

Update your computer BIOS using the BIOS update.exe file that is copied to a FAT32 USB drive and booting from the F12 One-Time boot menu.

About this task

BIOS Update

You can run the BIOS update file from Windows using a bootable USB drive or you can also update the BIOS from the F12 One-Time boot menu on the computer.

Most of the Dell computers built after 2012 have this capability, and you can confirm by booting your computer to the F12 One-Time Boot Menu to see if BIOS FLASH UPDATE is listed as a boot option for your computer. If the option is listed, then the BIOS supports this BIOS update option.

 **NOTE:** Only computers with BIOS Flash Update option in the F12 One-Time boot menu can use this function.

Updating from the One-Time boot menu

To update your BIOS from the F12 One-Time boot menu, you need the following:

- USB drive formatted to the FAT32 file system (key does not have to be bootable)
- BIOS executable file that you downloaded from the Dell Support website and copied to the root of the USB drive
- AC power adapter that is connected to the computer
- Functional computer battery to flash the BIOS

Perform the following steps to perform the BIOS update flash process from the F12 menu:

 **CAUTION:** Do not turn off the computer during the BIOS update process. The computer may not boot if you turn off your computer.

Steps

1. From a turn off state, insert the USB drive where you copied the flash into a USB port of the computer.
2. Turn on the computer and press F12 to access the One-Time Boot Menu, select BIOS Update using the mouse or arrow keys then press Enter.
The flash BIOS menu is displayed.
3. Click **Flash from file**.
4. Select external USB device.
5. Select the file and double-click the flash target file, and then click **Submit**.
6. Click **Update BIOS**. The computer restarts to flash the BIOS.
7. The computer will restart after the BIOS update is completed.

System and setup password

Table 39. System and setup password

Password type	Description
System password	Password that you must enter to log in to your system.
Setup password	Password that you must enter to access and make changes to the BIOS settings of your computer.

You can create a system password and a setup password to secure your computer.

 **CAUTION:** The password features provide a basic level of security for the data on your computer.

 **CAUTION:** Anyone can access the data that is stored on your computer if it is not locked and left unattended.

 **NOTE:** System and setup password feature is disabled.

Assigning a system setup password

Prerequisites

You can assign a new **System or Admin Password** only when the status is in **Not Set**.

About this task

To enter the system setup, press F12 immediately after a power-on or reboot.

Steps

1. In the **System BIOS** or **System Setup** screen, select **Security** and press Enter.
The **Security** screen is displayed.
2. Select **System/Admin Password** and create a password in the **Enter the new password** field.
Use the following guidelines to assign the system password:
 - A password can have up to 32 characters.
 - At least one special character: ! " # \$ % & ' () * + , - . / : ; < = > ? @ [\] ^ _ ` { | }
 - Numbers 0 through 9.
 - Upper case letters from A to Z.
 - Lower case letters from a to z.
3. Type the system password that you entered earlier in the **Confirm new password** field and click **OK**.
4. Press Esc and save the changes as prompted by the pop-up message.
5. Press Y to save the changes.
The computer restarts.

Deleting or changing an existing system setup password

Prerequisites

Ensure that the **Password Status** is Unlocked (in the System Setup) before attempting to delete or change the existing System and/or Setup password. You cannot delete or change an existing System or Setup password, if the **Password Status** is Locked.

About this task

To enter the System Setup, press F12 immediately after a power-on or reboot.

Steps

1. In the **System BIOS** or **System Setup** screen, select **System Security** and press Enter.
The **System Security** screen is displayed.
2. In the **System Security** screen, verify that **Password Status** is **Unlocked**.
3. Select **System Password**, update, or delete the existing system password, and press Enter or Tab.
4. Select **Setup Password**, update, or delete the existing setup password, and press Enter or Tab.
 **NOTE:** If you change the System and/or Setup password, reenter the new password when prompted. If you delete the System and/or Setup password, confirm the deletion when prompted.
5. Press Esc and a message prompts you to save the changes.
6. Press Y to save the changes and exit from System Setup.
The computer restarts.

Clearing CMOS settings

About this task

 **CAUTION:** Clearing CMOS settings will reset the BIOS settings on your computer.

Steps

1. Remove the [base cover](#).
2. Disconnect the battery cable from the system board.
3. Remove the [coin-cell battery](#).
4. Wait for one minute.
5. Install the [coin-cell battery](#).
6. Connect the battery cable to the system board.

7. Install the [base cover](#).

Clearing BIOS (System Setup) and System passwords

About this task

To clear the system or BIOS passwords, contact Dell technical support as described at www.dell.com/contactdell.

 **NOTE:** For information on how to reset Windows or application passwords, refer to the documentation accompanying Windows or your application.

Troubleshooting

Handling swollen Lithium-ion batteries

Like most laptops, Dell laptops use lithium-ion batteries. One type of lithium-ion battery is the lithium-ion polymer battery. Lithium-ion polymer batteries have increased in popularity in recent years and have become standard in the electronics industry due to customer preferences for a slim form factor (especially with newer ultra-thin laptops) and long battery life. Inherent to lithium-ion polymer battery technology is the potential for swelling of the battery cells.

Swollen battery may impact the performance of the laptop. To prevent possible further damage to the device enclosure or internal components leading to malfunction, discontinue the use of the laptop and discharge it by disconnecting the AC adapter and letting the battery drain.

Swollen batteries should not be used and should be replaced and disposed of properly. We recommend contacting Dell product support for options to replace a swollen battery under the terms of the applicable warranty or service contract, including options for replacement by a Dell authorized service technician.

The guidelines for handling and replacing Lithium-ion batteries are as follows:

- Exercise caution when handling Lithium-ion batteries.
- Discharge the battery before removing it from the system. To discharge the battery, unplug the AC adapter from the system and operate the system only on battery power. When the system will no longer power on when the power button is pressed, the battery is fully discharged.
- Do not crush, drop, mutilate, or penetrate the battery with foreign objects.
- Do not expose the battery to high temperatures, or disassemble battery packs and cells.
- Do not apply pressure to the surface of the battery.
- Do not bend the battery.
- Do not use tools of any type to pry on or against the battery.
- If a battery gets stuck in a device as a result of swelling, do not try to free it as puncturing, bending, or crushing a battery can be dangerous.
- Do not attempt to reassemble a damaged or swollen battery into a laptop.
- Swollen batteries that are covered under warranty should be returned to Dell in an approved shipping container (provided by Dell)—this is to comply with transportation regulations. Swollen batteries that are not covered under warranty should be disposed of at an approved recycling center. Contact Dell product support at <https://www.dell.com/support> for assistance and further instructions.
- Using a non-Dell or incompatible battery may increase the risk of fire or explosion. Replace the battery only with a compatible battery purchased from Dell that is designed to work with your Dell computer. Do not use a battery from other computers with your computer. Always purchase genuine batteries from <https://www.dell.com> or otherwise directly from Dell.

Lithium-ion batteries can swell for various reasons such as age, number of charge cycles, or exposure to high heat. For more information on how to improve the performance and lifespan of the laptop battery and to minimize the possibility of occurrence of the issue, search Dell Laptop Battery in the Knowledge Base Resource at www.dell.com/support.

Locate the Service Tag or Express Service Code of your Dell computer

Your Dell computer is uniquely identified by a Service Tag or Express Service Code. To view relevant support resources for your Dell computer, we recommend entering the Service Tag or Express Service Code at www.dell.com/support.

For more information on how to find the Service Tag for your computer, see [Locate the Service Tag for your Dell Laptop](#).

Dell SupportAssist Pre-boot System Performance Check diagnostics

About this task

SupportAssist diagnostics (also known as system diagnostics) performs a complete check of your hardware. The Dell SupportAssist Pre-boot System Performance Check diagnostics is embedded with the BIOS and is launched by the BIOS internally. The embedded system diagnostics provides a set of options for particular devices or device groups allowing you to:

- Run tests automatically or in an interactive mode
- Repeat tests
- Display or save test results
- Run thorough tests to introduce additional test options to provide extra information about the failed device(s)
- View status messages that inform you if tests are completed successfully
- View error messages that inform you of problems encountered during testing

 **NOTE:** Some tests for specific devices require user interaction. Always ensure that you are present at the computer terminal when the diagnostic tests are performed.

For more information, see <https://www.dell.com/support/kbdoc/000180971>.

Running the SupportAssist Pre-Boot System Performance Check

Steps

1. Turn on your computer.
2. As the computer boots, press the F12 key as the Dell logo appears.
3. On the boot menu screen, select the **Diagnostics** option.
4. Click the arrow at the bottom left corner.
Diagnostics front page is displayed.
5. Click the arrow in the lower-right corner to go to the page listing.
The items detected are listed.
6. To run a diagnostic test on a specific device, press Esc and click **Yes** to stop the diagnostic test.
7. Select the device from the left pane and click **Run Tests**.
8. If there are any issues, error codes are displayed.
Note the error code and validation number and contact Dell.

Built-in self-test (BIST)

M-BIST

M-BIST (Built In Self-Test) is the system board's built-in self-test diagnostics tool that improves the diagnostics accuracy of system board embedded controller (EC) failures.

 **NOTE:** M-BIST can be manually initiated before POST (Power On Self Test).

How to run M-BIST

 **NOTE:** M-BIST must be initiated on the system from a power-off state either connected to AC power or with battery only.

1. Press and hold both the **M** key on the keyboard and the **power button** to initiate M-BIST.
2. With both the **M** key and the **power button** held down, the battery indicator LED may exhibit two states:
 - a. OFF: No fault detected with the system board
 - b. AMBER: Indicates a problem with the system board
3. If there is a failure with the system board, the battery status LED will flash one of the following error codes for 30 seconds:

Table 40. LED error codes

Blinking Pattern		Possible Problem
Amber	White	
2	1	CPU Failure
2	8	LCD Power Rail Failure
1	1	TPM Detection Failure
2	4	Unrecoverable SPI Failure

4. If there is no failure with the system board, the LCD will cycle through the solid color screens described in the LCD-BIST section for 30 seconds and then power off.

LCD Power rail test (L-BIST)

L-BIST is an enhancement to the single LED error code diagnostics and is automatically initiated during POST. L-BIST will check the LCD power rail. If there is no power being supplied to the LCD (i.e., the L-BIST circuit fails), the battery status LED will flash either an error code [2,8] or an error code [2,7].

 **NOTE:** If L-BIST fails, LCD-BIST cannot function as no power will be supplied to the LCD.

How to invoke L-BIST Test:

1. Press the power button to start the system.
2. If the system does not start up normally, look at the battery status LED:
 - If the battery status LED flashes an error code [2,7], the display cable may not be connected properly.
 - If the battery status LED flashes an error code [2,8], there is a failure on the LCD power rail of the system board, hence there is no power supplied to the LCD.
3. For cases, when a [2,7] error code is shown, check to see if the display cable is properly connected.
4. For cases when a [2,8] error code is shown, replace the system board.

LCD Built-in Self Test (BIST)

Dell laptops have a built-in diagnostic tool that helps you determine if the screen abnormality you are experiencing is an inherent problem with the LCD (screen) of the Dell laptop or with the video card (GPU) and PC settings.

When you notice screen abnormalities like flickering, distortion, clarity issues, fuzzy or blurry image, horizontal or vertical lines, color fade etc., it is always a good practice to isolate the LCD (screen) by running the Built-In Self Test (BIST).

How to invoke LCD BIST Test

1. Power off the Dell laptop.
2. Disconnect any peripherals that are connected to the laptop. Connect only the AC adapter (charger) to the laptop.
3. Ensure that the LCD (screen) is clean (no dust particles on the surface of the screen).
4. Press and hold **D** key and **Power on** the laptop to enter LCD built-in self test (BIST) mode. Continue to hold the D key, until the system boots up.
5. The screen will display solid colors and change colors on the entire screen to white, black, red, green, and blue twice.
6. Then it will display the colors white, black and red.
7. Carefully inspect the screen for abnormalities (any lines, fuzzy color or distortion on the screen).
8. At the end of the last solid color (red), the system will shut down.

 **NOTE:** Dell SupportAssist Pre-boot diagnostics upon launch, initiates an LCD BIST first, expecting a user intervention confirm functionality of the LCD.

System-diagnostic lights

Battery-status light

Indicates the power and battery-charge status.

Solid white — Power adapter is connected and the battery has more than 5 percent charge.

Amber — Computer is running on battery and the battery has less than 5 percent charge.

Off

- Power adapter is connected, and the battery is fully charged.
- Computer is running on battery, and the battery has more than 5 percent charge.
- Computer is in sleep state, hibernation, or turned off.

The battery-status light blinks amber along with beep codes indicating failures.

For example, the battery-status light blinks amber two times followed by a pause, and then blinks white three times followed by a pause. This 2,3 pattern continues until the computer is turned off indicating no memory or RAM is detected.

The following table shows different power and battery-status light patterns and associated problems.

Table 41. System-diagnostic lights

Blinking pattern		Problem description	Suggested resolution
Amber	White		
1	1	TPM detection failure	Replace the system board.
1	2	Unrecoverable SPI Flash Failure	Replace the system board.
1	3	Short in hinge cable tripped OCP1	Check if the display cable (EDP) is seated properly or pinched at the hinges. If problem persists, replace either display cable (EDP) or display assembly (LCD).
1	4	Short in hinge cable tripped OCP2	Check if the display cable (EDP) is seated properly or pinched at the hinges. If problem persists, replace either display cable (EDP) or display assembly (LCD)
1	5	EC unable to program i-Fuse	Replace the system board.
1	6	Generic catch-all for ungraceful EC code flow errors	Disconnect all power source (AC, battery, coin cell) and drain flea power by pressing and holding down power button for 3~5 seconds.
1	7	Non-RPMC Flash on Boot Guard fused system	Replace the system board.
2	1	CPU failure	<ul style="list-style-type: none"> • Run the Dell Support Assist/Dell Diagnostics tool. • If problem persists, replace the system board.
2	2	System board failure (included BIOS corruption or ROM error)	<ul style="list-style-type: none"> • Flash latest BIOS version • If problem persists, replace the system board.

Table 41. System-diagnostic lights (continued)

Blinking pattern		Problem description	Suggested resolution
Amber	White		
2	3	No memory/RAM detected	<ul style="list-style-type: none"> • Confirm that the memory module is installed properly. • If problem persists, replace the memory module.
2	4	Memory/RAM failure	<ul style="list-style-type: none"> • Reset and swap memory modules among the slots. • If problem persists, replace the memory module.
2	5	Invalid memory installed	<ul style="list-style-type: none"> • Reset and swap memory modules among the slots. • If problem persists, replace the memory module.
2	6	System board/Chipset Error	Replace the system board.
2	7	LCD failure (SBIOS message)	Replace the LCD module.
2	8	LCD failure (EC detection of power rail failure)	Replace the system board.
3	1	CMOS battery failure	<ul style="list-style-type: none"> • Reset the main battery connection. • If problem persists, replace the main battery.
3	2	PCI or Video card/chip failure	Replace the system board.
3	3	BIOS recovery image not found	<ul style="list-style-type: none"> • Flash latest BIOS version • If problem persists, replace the system board.
3	4	BIOS recovery image found but invalid	<ul style="list-style-type: none"> • Flash latest BIOS version • If problem persists, replace the system board.
3	5	Power rail failure	Replace the system board.
3	6	Flash corruption detected by SBIOS.	<ul style="list-style-type: none"> • Press power button for over 25 seconds to do RTC reset. If problem persists, replace the system board. • Disconnect all power source (AC, battery, coin cell) and drain flea power by pressing and holding down power button 3~5 seconds to ensure all power are drained. • Run "BIOS recovery from USB", and the instructions are in the website Dell support.

Table 41. System-diagnostic lights (continued)

Blinking pattern		Problem description	Suggested resolution
Amber	White		
			<ul style="list-style-type: none"> If problem persists, replace the system board.
3	7	Timeout waiting on ME to reply to HECI message.	Replace the system board.

NOTE: Blinking 3-3-3 LEDs on Lock LED (Caps-Lock or Num-Lock), Power button LED (without Fingerprint reader), and Diagnostic LED indicates failure to provide input during LCD panel test on Dell SupportAssist Pre-boot System Performance Check diagnostics.

Camera status light: Indicates whether the camera is in use.

- Solid white — Camera is in use.
- Off — Camera is not in use.

Caps Lock status light: Indicates whether Caps Lock is enabled or disabled.

- Solid white — Caps Lock enabled.
- Off — Caps Lock disabled.

Recovering the operating system

When your computer is unable to boot to the operating system even after repeated attempts, it automatically starts Dell SupportAssist OS Recovery.

Dell SupportAssist OS Recovery is a standalone tool that is preinstalled in all Dell computers installed with Windows operating system. It consists of tools to diagnose and troubleshoot issues that may occur before your computer boots to the operating system. It enables you to diagnose hardware issues, repair your computer, back up your files, or restore your computer to its factory state.

You can also download it from the Dell Support website to troubleshoot and fix your computer when it fails to boot into their primary operating system due to software or hardware failures.

For more information about the Dell SupportAssist OS Recovery, see *Dell SupportAssist OS Recovery User's Guide* at www.dell.com/serviceabilitytools. Click **SupportAssist** and then, click **SupportAssist OS Recovery**.

Real-Time Clock (RTC Reset)

The Real Time Clock (RTC) reset function allows you or the service technician to recover Dell systems from No POST/No Power/No Boot situations. The legacy jumper enabled RTC reset has been retired on these models.

Start the RTC reset with the system powered off and connected to AC power. Press and hold the power button for twenty (20) seconds

. The system RTC Reset occurs after you release the power button.

Backup media and recovery options

It is recommended to create a recovery drive to troubleshoot and fix problems that may occur with Windows. Dell proposes multiple options for recovering Windows operating system on your Dell PC. For more information, see [Dell Windows Backup Media and Recovery Options](#).

WiFi power cycle

About this task

If your computer is unable to access the internet due to WiFi connectivity issues a WiFi power cycle procedure may be performed. The following procedure provides the instructions on how to conduct a WiFi power cycle:

 **NOTE:** Some ISPs (Internet Service Providers) provide a modem/router combo device.

Steps

1. Turn off your computer.
2. Turn off the modem.
3. Turn off the wireless router.
4. Wait for 30 seconds.
5. Turn on the wireless router.
6. Turn on the modem.
7. Turn on your computer.

Drain residual flea power (perform hard reset)

About this task

Flea power is the residual static electricity that remains in the computer even after it has been powered off and the battery is removed.

For your safety, and to protect the sensitive electronic components in your computer, you are requested to drain residual flea power before removing or replacing any components in your computer.

Draining residual flea power, also known as a performing a "hard reset", is also a common troubleshooting step if your computer does not power on or boot into the operating system.

To drain residual flea power (perform a hard reset)

Steps

1. Turn off your computer.
2. Disconnect the power adapter from your computer.
3. Remove the base cover.
4. Remove the battery.
5. Press and hold the power button for 20 seconds to drain the flea power.
6. Install the battery.
7. Install the base cover.
8. Connect the power adapter to your computer.
9. Turn on your computer.



 **NOTE:** For more information about performing a hard reset, search in the Knowledge Base Resource at www.dell.com/support.

Getting help and contacting Dell

Self-help resources

You can get information and help on Dell products and services using these self-help resources:

Table 42. Self-help resources

Self-help resources	Resource location
Information about Dell products and services	www.dell.com
My Dell app	
Tips	
Contact Support	In Windows search, type <code>Contact Support</code> , and press Enter.
Online help for operating system	www.dell.com/support/windows
Access top solutions, diagnostics, drivers and downloads, and learn more about your computer through videos, manuals and documents.	Your Dell computer is uniquely identified by a Service Tag or Express Service Code. To view relevant support resources for your Dell computer, enter the Service Tag or Express Service Code at www.dell.com/support . For more information on how to find the Service Tag for your computer, see Locate the Service Tag on your computer .
Dell knowledge base articles for a variety of computer concerns	<ol style="list-style-type: none"> 1. Go to www.dell.com/support. 2. On the menu bar at the top of the Support page, select Support > Knowledge Base. 3. In the Search field on the Knowledge Base page, type the keyword, topic, or model number, and then click or tap the search icon to view the related articles.

Contacting Dell

To contact Dell for sales, technical support, or customer service issues, see www.dell.com/contactdell.

 **NOTE:** Availability varies by country/region and product, and some services may not be available in your country/region.

 **NOTE:** If you do not have an active Internet connection, you can find contact information about your purchase invoice, packing slip, bill, or Dell product catalog.