



RAZER BLACKWIDOW LITE

MASTER GUIDE

The **Razer BlackWidow Lite** delivers full functionality in a compact form. Featuring Razer™ Mechanical Switches (Orange) with included o-rings for extra sound dampening, experience silent but tactile feedback. The keyboard is also equipped with individually backlit keys with full brightness control. Use Razer Synapse 3, a cloud-based hardware configuration tool, to access advanced options like assigning macros, setting shortcuts, and more.

CONTENTS

1. PACKAGE CONTENTS / SYSTEM REQUIREMENTS.....	3
2. REGISTRATION / TECHNICAL SUPPORT.....	4
3. TECHNICAL SPECIFICATIONS.....	5
4. DEVICE LAYOUT.....	6
5. INSTALLING RAZER SYNAPSE 3 FOR YOUR RAZER BLACKWIDOW LITE.....	7
6. USING YOUR RAZER BLACKWIDOW LITE.....	8
7. CONFIGURING YOUR RAZER BLACKWIDOW LITE VIA RAZER SYNAPSE 3.....	10
8. SAFETY AND MAINTENANCE	26
9. LEGALESE	28

1. PACKAGE CONTENTS / SYSTEM REQUIREMENTS

PACKAGE CONTENTS

- Razer BlackWidow Lite silent mechanical keyboard
- Micro-USB to USB cable
- Keycap puller and O-Rings
- Important Product Information Guide

SYSTEM REQUIREMENTS

HARDWARE REQUIREMENTS

- PC with a free USB port

RAZER SYNAPSE 3 REQUIREMENTS

- Windows® 7 64-bit (or higher)
- Internet connection
- 500 MB of free hard disk space

2. REGISTRATION / TECHNICAL SUPPORT

REGISTRATION

Register your product online at razerid.razer.com/warranty using your Razer ID to get real-time information on your product's warranty status.

If you haven't registered for a Razer ID yet, register now at razerid.razer.com to get a wide range of Razer benefits.

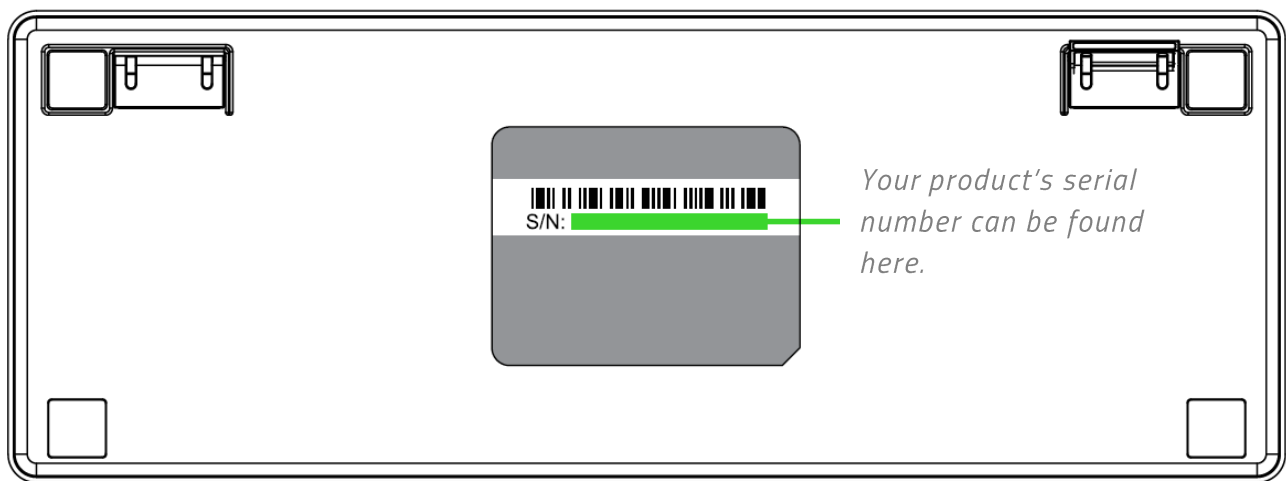

TECHNICAL SUPPORT

- 2 years limited manufacturer's warranty.
- Free online technical support at support.razer.com

3. TECHNICAL SPECIFICATIONS

FEATURES

- Razer™ Orange Mechanical Switches designed for gaming
- 80 million keystroke lifespan
- Individually backlit keys with full brightness control
- Included o-rings and keycap puller
- Razer Synapse 3 enabled
- Detachable braided fiber cable with strap
- 10-key rollover anti-ghosting
- Fully programmable keys
- 1000 Hz Ultrapolling
- Aluminum matte top plate
- Instant Trigger Technology

APPROXIMATE SIZE & WEIGHT

- Length: 361 mm / 14.2 in
- Width: 133 mm / 5.2 in
- Height: 36.2 mm / 1.42 in
- Weight: 660.9 g / 1.46 lbs

4. DEVICE LAYOUT

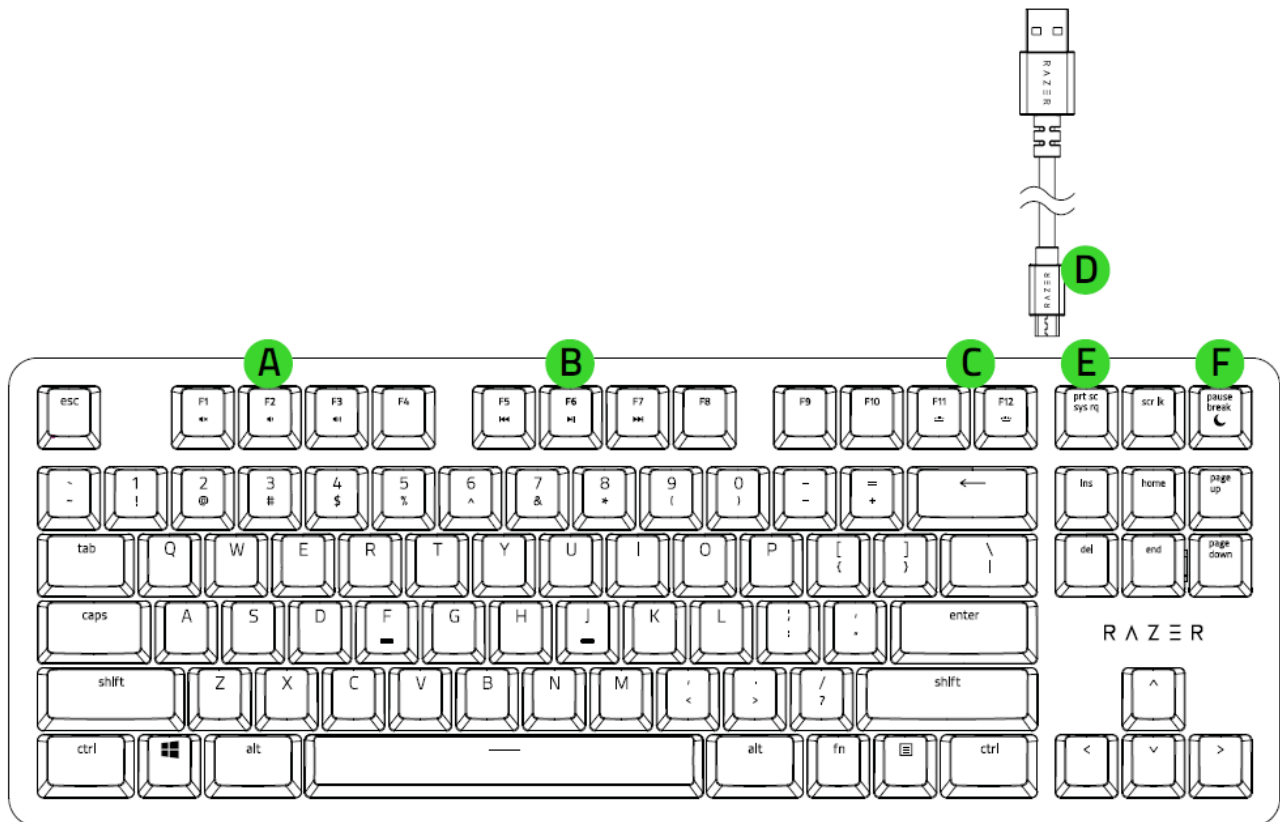

- A. Volume control keys
- B. Media keys
- C. Backlight control keys
- D. Micro-USB to USB cable
- E. Micro-USB port
- F. Sleep mode key

5. INSTALLING RAZER SYNAPSE 3 FOR YOUR RAZER BLACKWIDOW LITE

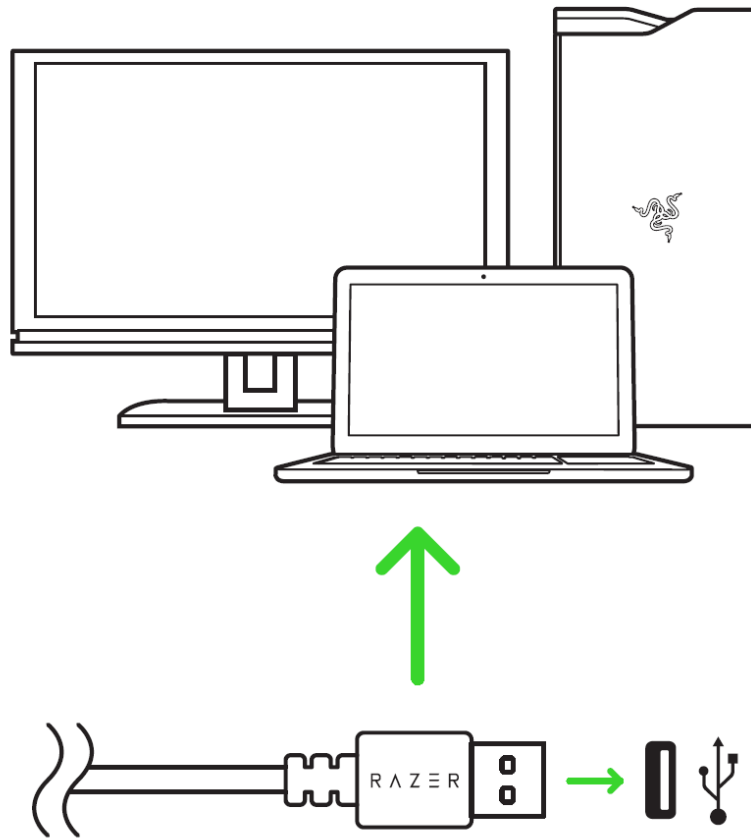

Step 1: Make sure your Razer device is connected to the USB port of your computer.

Step 2: Install Razer Synapse 3 when prompted* or download the installer from razer.com/synapse.

Step 3: Register for a Razer ID or log in with an existing account.

**Applicable for Windows 8 or later.*

6. USING YOUR RAZER BLACKWIDOW LITE



When the "fn" key is held down, all function keys with secondary functions including other keys which you can combine with the "fn" key will light up. Pressing the "fn" key in combination with the function keys will activate their secondary features on your PC.

Function Keys	Features Description
Three keycaps: F1 with a speaker and 'x' icon, F2 with a speaker icon, and F3 with a speaker and ' ' icon.	The audio volume controls allow you to mute (), decrease () and increase () the audio output.
Three keycaps: F5 with a double left arrow icon, F6 with a play/pause icon, and F7 with a double right arrow icon.	The media keys allow you to play/pause () a track or skip tracks backward () and forward ().
Two keycaps: F11 with a crown icon, and F12 with a crown icon.	The backlight control keys allow you to decrease () or increase () the brightness of your keyboard's LEDs.
A keycap labeled "pause break" with a crescent moon icon.	The sleep key allows you to suspend all operating system activities. This function allows you to save electricity while the computer is idle.

USING THE KEYCAP PULLER AND O-RINGS

The Razer BlackWidow Lite comes with o-rings which can be installed in each keycap to reduce switch travel distance and further dampen the sound of each keystroke. Simply follow these steps to install an o-ring to any of your keyboard's keycaps:

1. Use the keycap puller to remove a keycap.

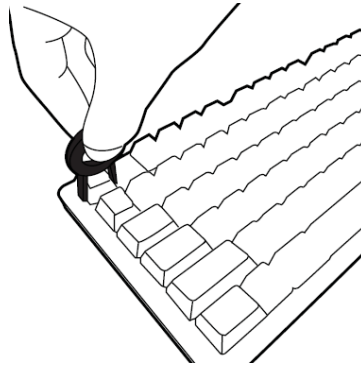

2. Insert an o-ring into the stem of the removed keycap.

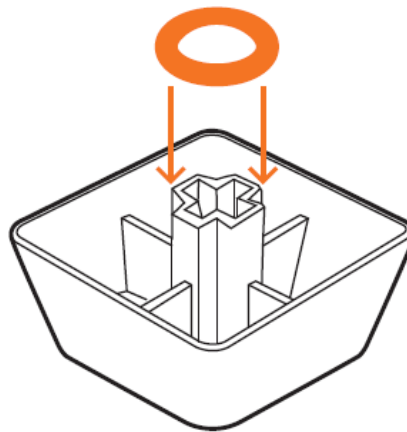

3. Push the keycap back in place.

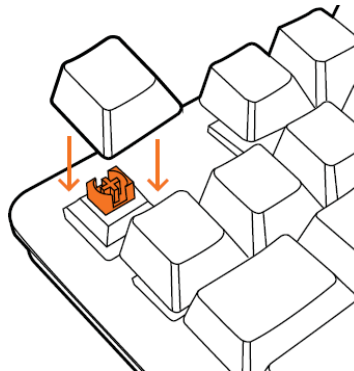

4. Repeat steps 1 to 3 for the other keycaps.

7. CONFIGURING YOUR RAZER BLACKWIDOW LITE VIA RAZER SYNAPSE 3

i *Disclaimer: The features listed here require you to log into Razer Synapse 3. These features are also subject to change based on the current software version and your Operating System.*

SYNAPSE TAB

The Synapse tab is your default tab when you first launch Razer Synapse 3.

Dashboard

The Dashboard subtab is an overview of your Razer Synapse 3 where you can access all your Razer devices, modules, and online services.

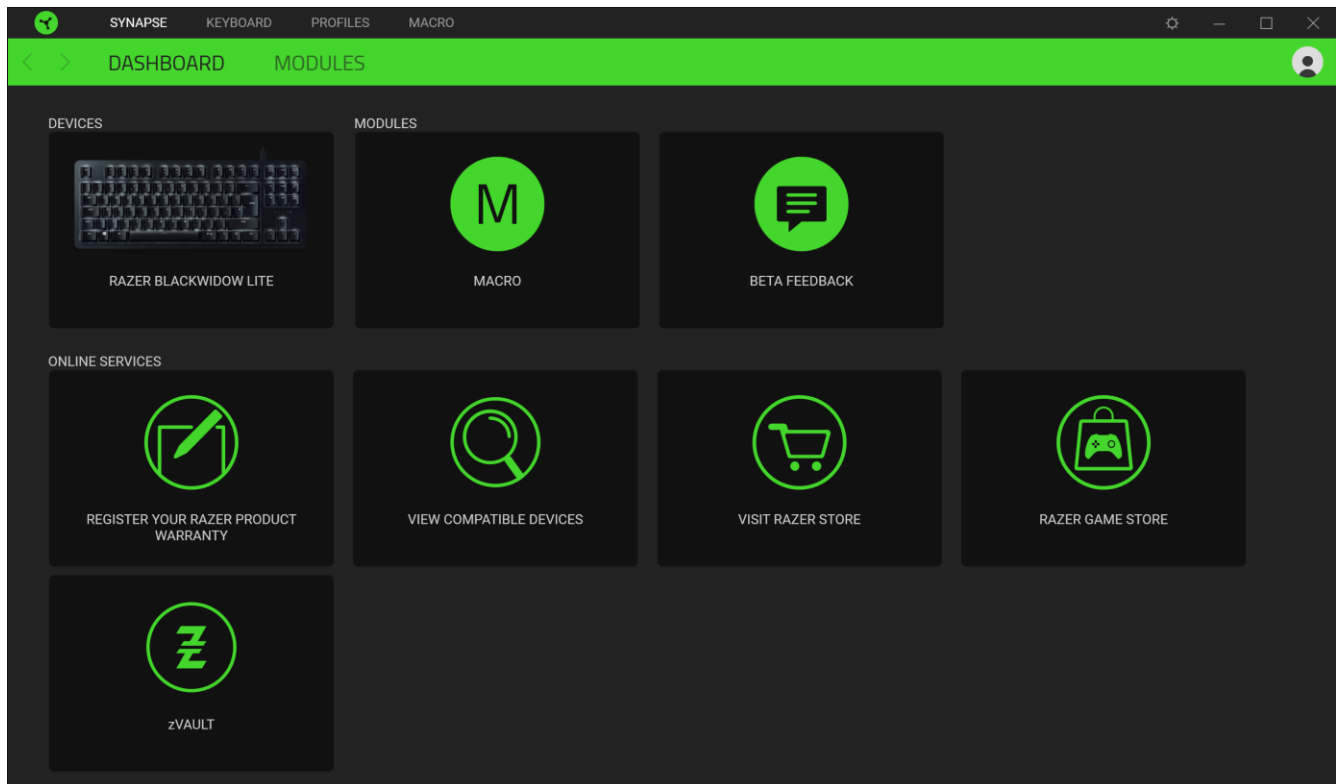

Modules

The Modules subtab displays all installed and available modules for installation.

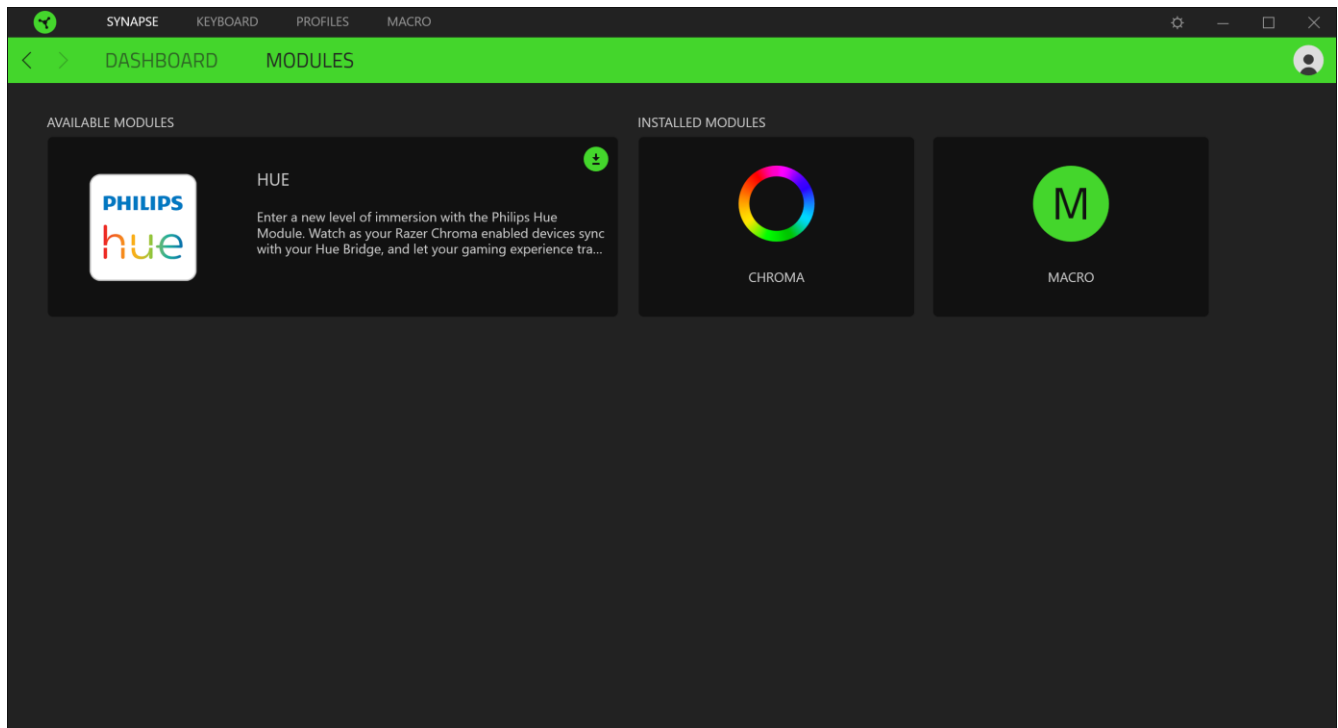

KEYBOARD

The Keyboard tab is the main tab for your Razer BlackWidow Lite. From here, you can change your device settings such as key assignments and your device's lighting. Changes made under this tab are automatically saved to your system and cloud storage.

Customize

The Customize subtab is for modifying your keyboard's key assignments.

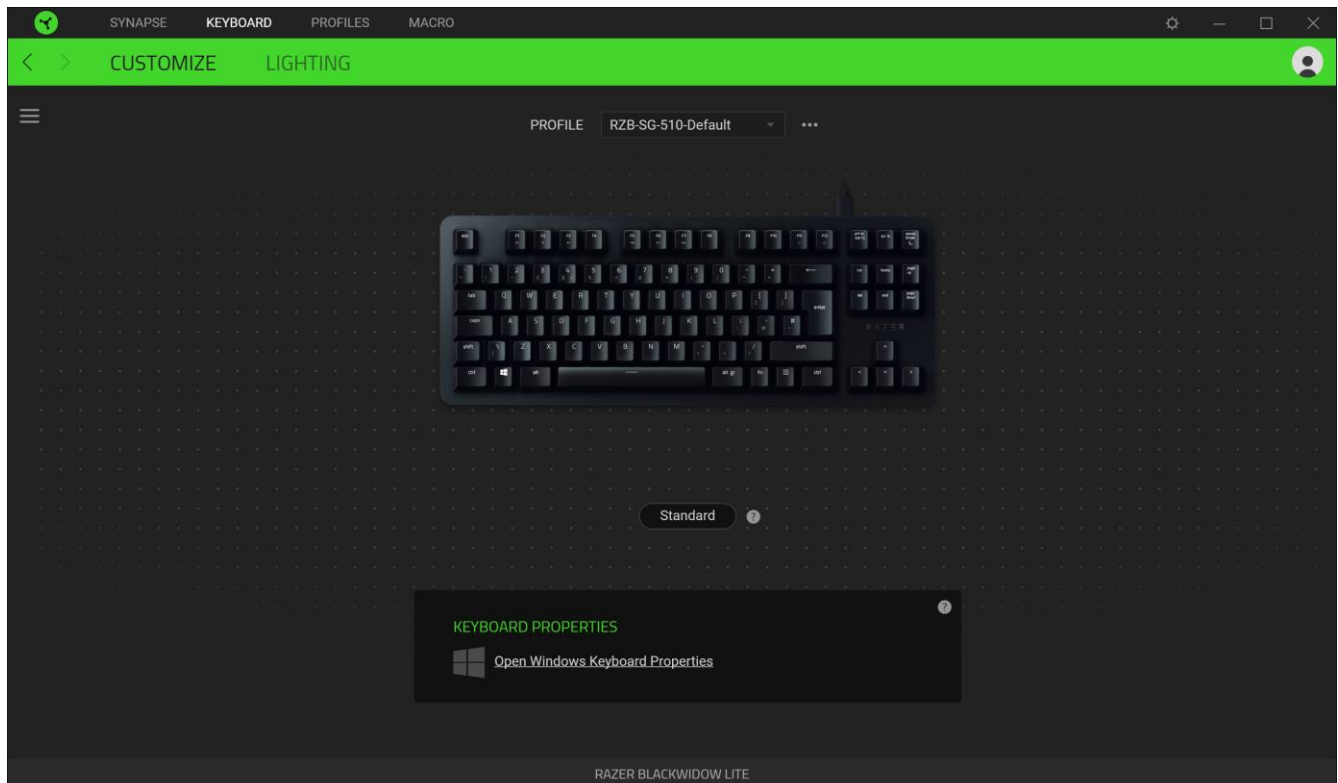

Profile

Profile is a data storage for keeping all your Razer peripheral's settings. By default, the profile name is based on your system's name. To add, import, rename, duplicate, export, or delete a profile, simply press the profile's corresponding Miscellaneous button (●●●).

Hypershift

Hypershift mode is a secondary set of key assignments that is activated when the Hypershift key is held down. By default, the Hypershift key is assigned to the “fn” key of your Razer Synapse 3 supported keyboard however, you can also assign any key as a Hypershift key.

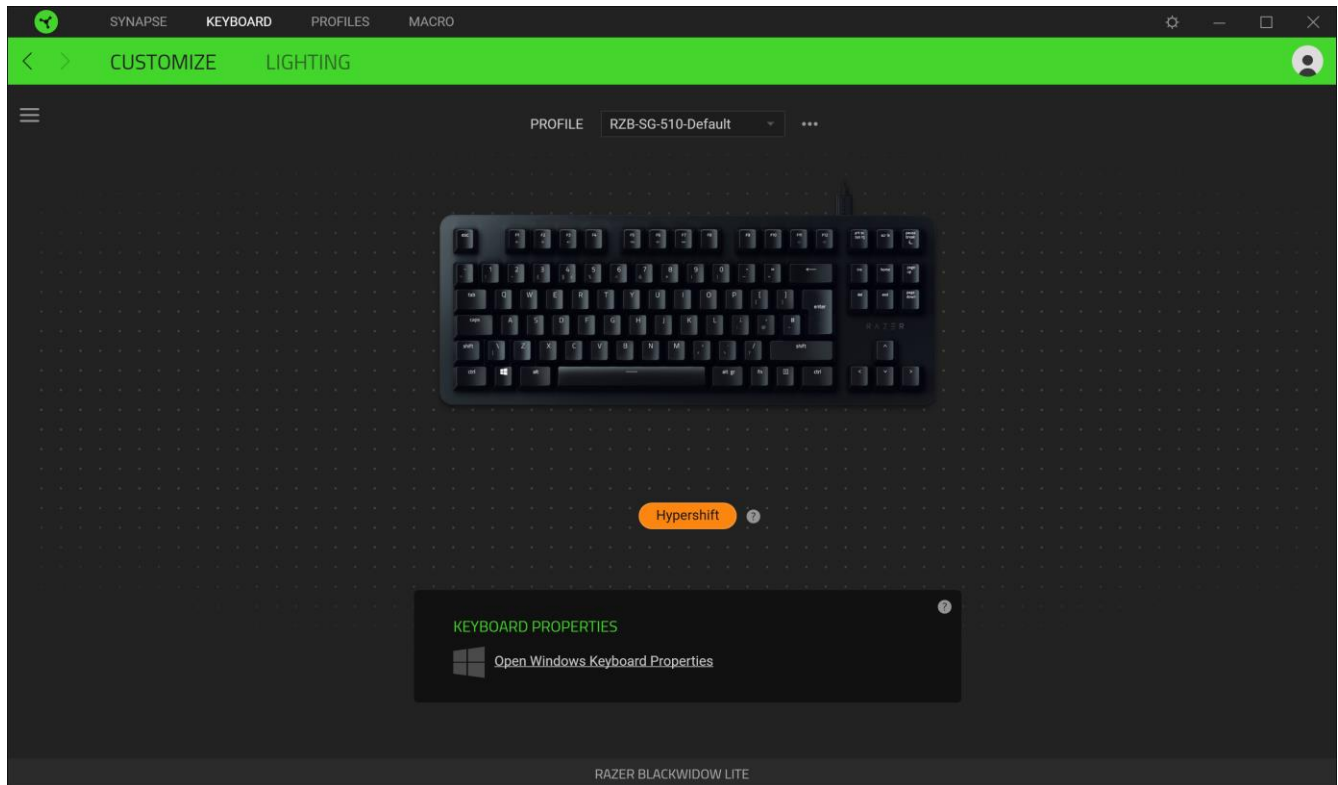

Sidebar

Clicking the Sidebar button (☰) will reveal all current key assignments for your Razer BlackWidow Lite.

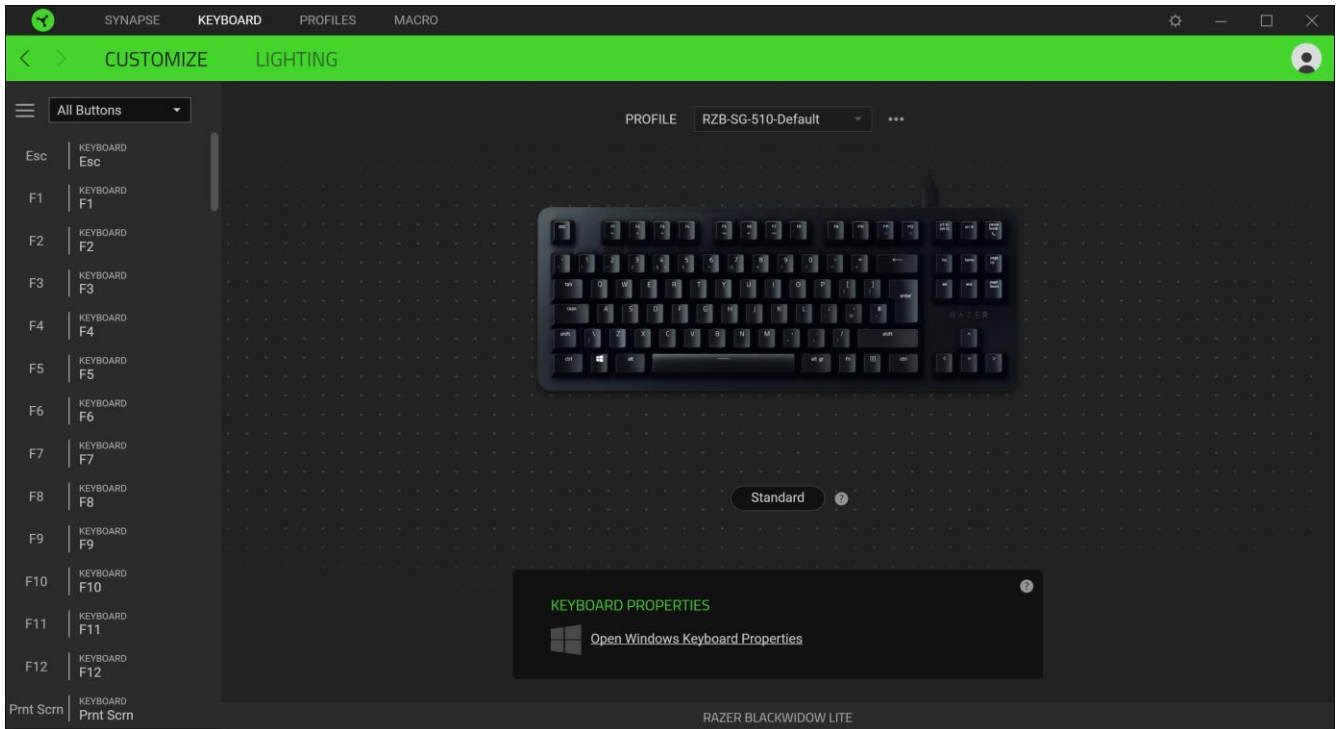

Alternatively, you can skip to a specific key assignment by selecting it on the Customize tab.

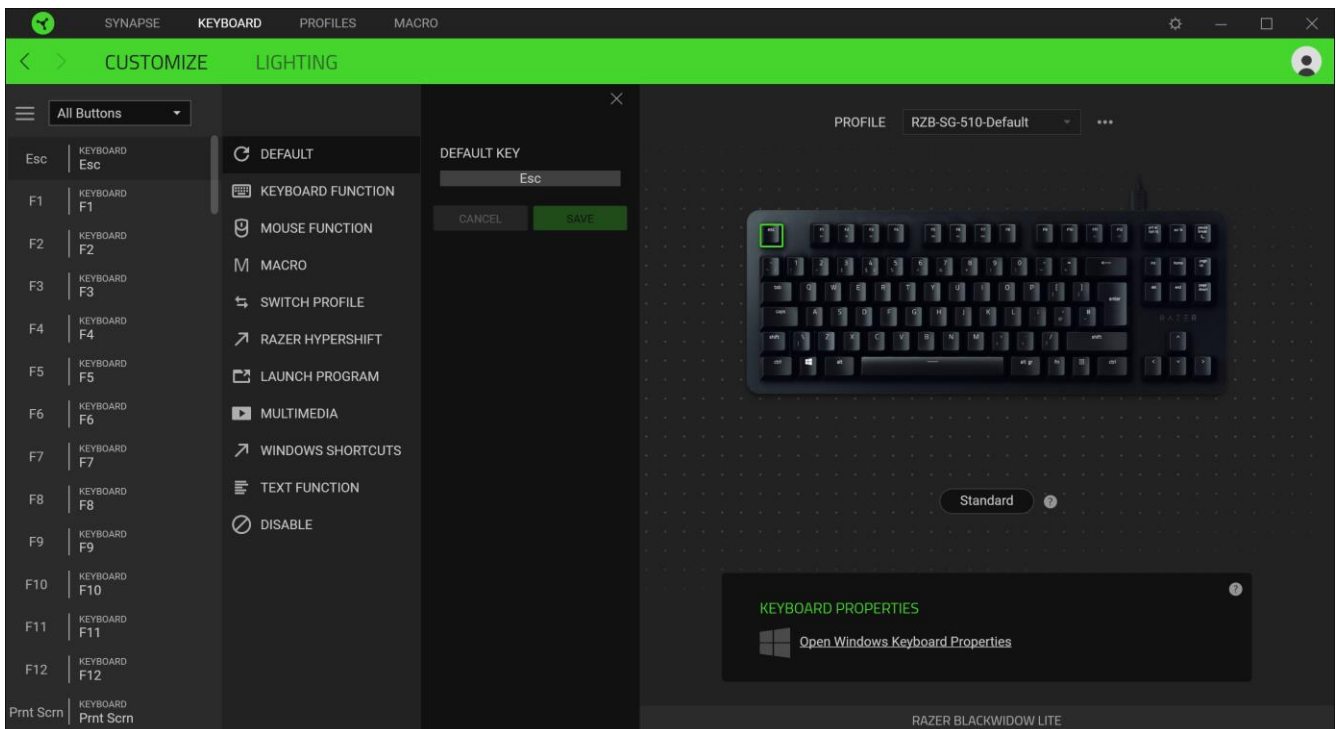

Upon selecting a key assignment, you may then change it to one of the following functions:

Default

This option enables you to return the selected key to its original setting.

Keyboard Function

This option changes the key assignment into a keyboard function. You can also choose enable Turbo mode which allows you to emulate repeatedly pressing the keyboard function while the key is held down.

Mouse Function

This option allows you to change any key into a mouse function. Listed below are the functions which you can choose from:

- Left Click - Performs a left mouse click using the assigned button.
- Right Click - Performs a right mouse click using the assigned button.
- Scroll Click - Activates the universal scrolling function.
- Double Click - Performs a double left click using the assigned button.
- Mouse Button 4 - Performs a "Backward" command for most internet browsers.
- Mouse Button 5 - Performs a "Forward" command for most internet browsers.
- Scroll Up - Performs a "Scroll Up" command using the assigned button.
- Scroll Down - Performs a "Scroll Down" command using the assigned button.
- Scroll Left - Performs a "Scroll Left" command using the assigned button.
- Scroll Right - Performs a "Scroll Right" command using the assigned button.

You can also choose to enable Turbo mode in some of the mouse functions which allow you to emulate repeatedly pressing and releasing said function while the key is held down.

M Macro

A Macro is a prerecorded sequence of keystrokes and button presses that is executed with precise timing. By setting the key function to Macro, you can conveniently execute a chain of commands. Do take note that this function will only be visible if you have installed the Macro module from the Modules tab. [Click here to learn more about Macros](#)

Switch Profile

Switch Profile enables you to quickly change profiles and load a new set of key assignments. An on-screen notification will appear whenever you switch profiles.

Launch Program

Launch Program enables you to open an app or a website using the assigned key. When you select Launch Program, two choices will appear which requires you to search for a specific app you want to open, or write the address of the website you want to visit.

Multimedia

This option allows you to assign multimedia controls to your Razer device. Listed below are the multimedia controls you can choose from:

- Volume Down - Decreases the audio output.
- Volume Up - Increases the audio output.
- Mute Volume - Mutes the audio.
- Mic Volume Up - Increases the microphone volume.
- Mic Volume Down - Decreases the microphone volume.
- Mute Mic - Mutes the microphone.
- Mute All - Mutes both microphone and audio output.
- Play / Pause - Play, pause, or resume playback of the current media.
- Previous Track - Play the previous media track.
- Next Track - Play the next media track.

Windows Shortcuts

This option allows you to assign your preferred key into a Windows Operating System shortcut command. For more information, please visit: support.microsoft.com/kb/126449

Text Function

Text Function enables you to type a prewritten text with a touch of a key. Simply write your desired text on the given field and your text will be typed whenever the assigned key is pressed. This function has full Unicode support and you can also insert special symbols from character maps.

 Disable

This option renders the assigned key unusable. Use Disable if you do not want to use the selected key or if it interferes with your gaming.

Keyboard Properties

Allows you to open the Windows Keyboard Properties where you can modify other keyboard settings such as Repeat delay, Repeat Rate, and Cursor blink rate, or view all keyboard drivers installed in your PC.

Lighting

The Lighting subtab enables you to modify your Razer device's light settings.

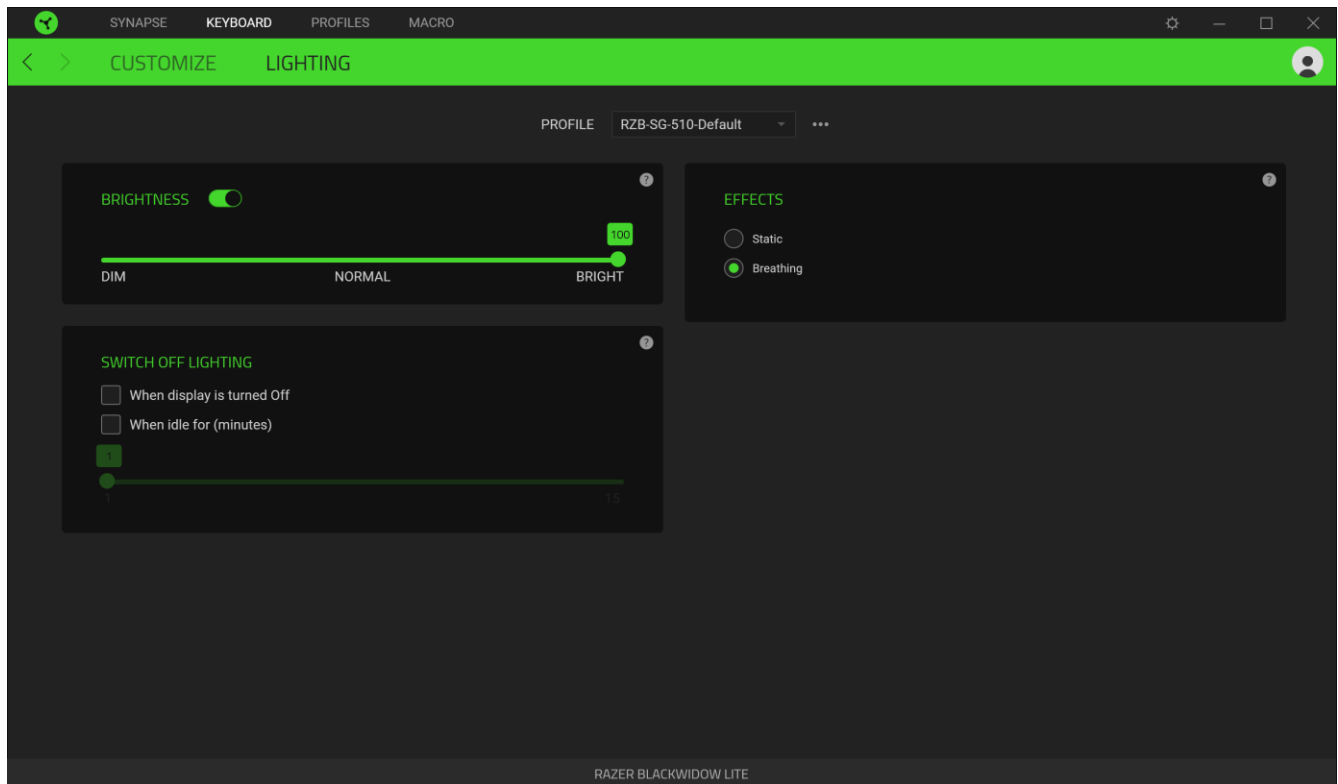

Brightness



You can turn off your Razer device's lighting by toggling the Brightness option or increase/decrease the luminance using the slider.

Switch Off Lighting

This is a power saving tool which allows you to disable your device's lighting in response to your system's display turning off and/or automatically power down when your Razer BlackWidow Lite has been idle for a set amount of time.

Effects

Select an effect to apply on your device's lighting, as listed here:

	Name	Description
	Breathing	The keyboard lighting will fade in and out
	Static	The keyboard lighting will remain lighted up



PROFILES TAB

The Profiles tab is a convenient way of managing all your profiles and linking them to your games and applications.

Devices

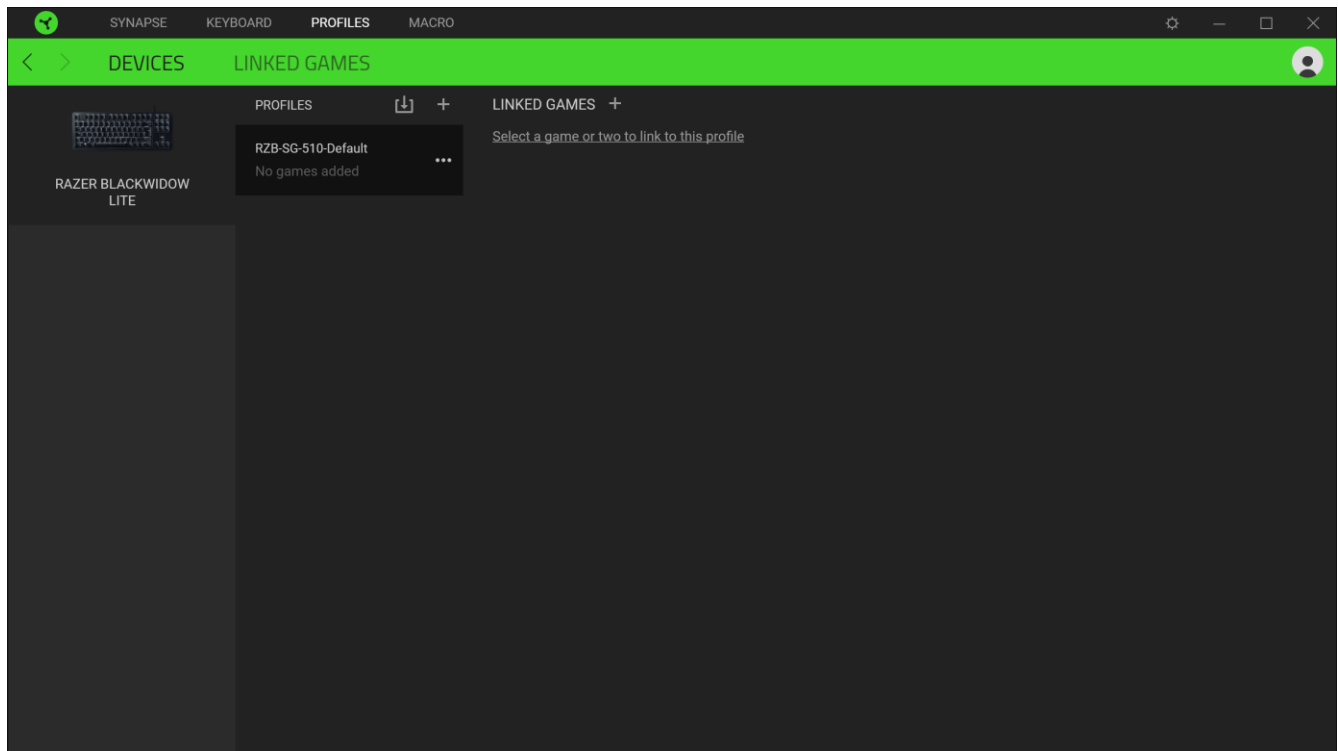
View which Razer device is using a specific profile using the Devices subtab.



You can import Profiles from your computer or from the cloud through the import button (), or create new profiles within the selected device using the add button (). To rename, duplicate, export, or delete a profile, simply press the Miscellaneous button (). Each profile can be set to automatically activate when you run an application using the Linked Games option.

Linked Games

The Linked Games subtab gives you the flexibility to add games, view peripherals that are linked to games, or search for added games. You can also sort games based on alphabetical order, last played, or most played. Added games will still be listed here even if it is not linked to a Razer device.

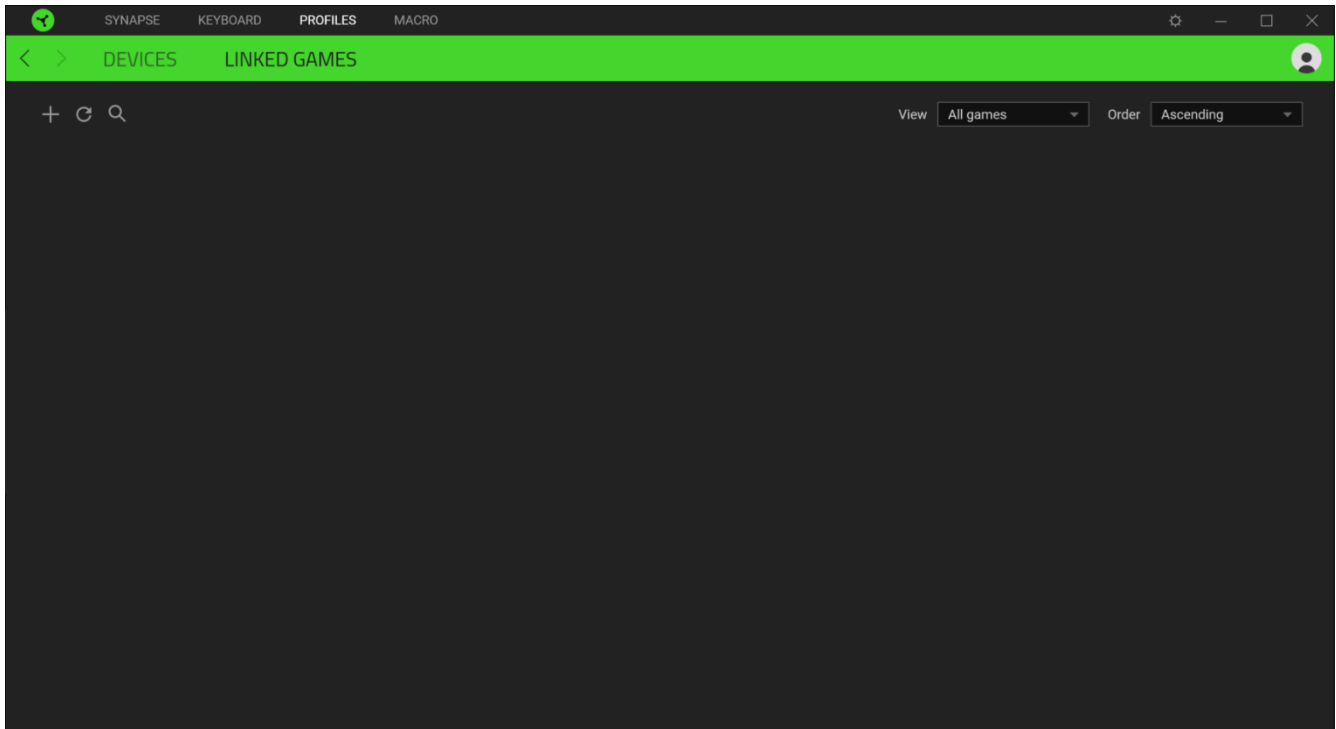



To link games to connected Razer devices, simply click on a game from the list, and then click the Select a device and its profile to launch automatically during gameplay button to select the Razer device it will link with.



Once linked, you may click on the Miscellaneous button (●●●) of the corresponding device to select a specific profile.

MACROS TAB

! *Note: The Macro tab will only be accessible once you have installed the Macro module from the Modules tab.*

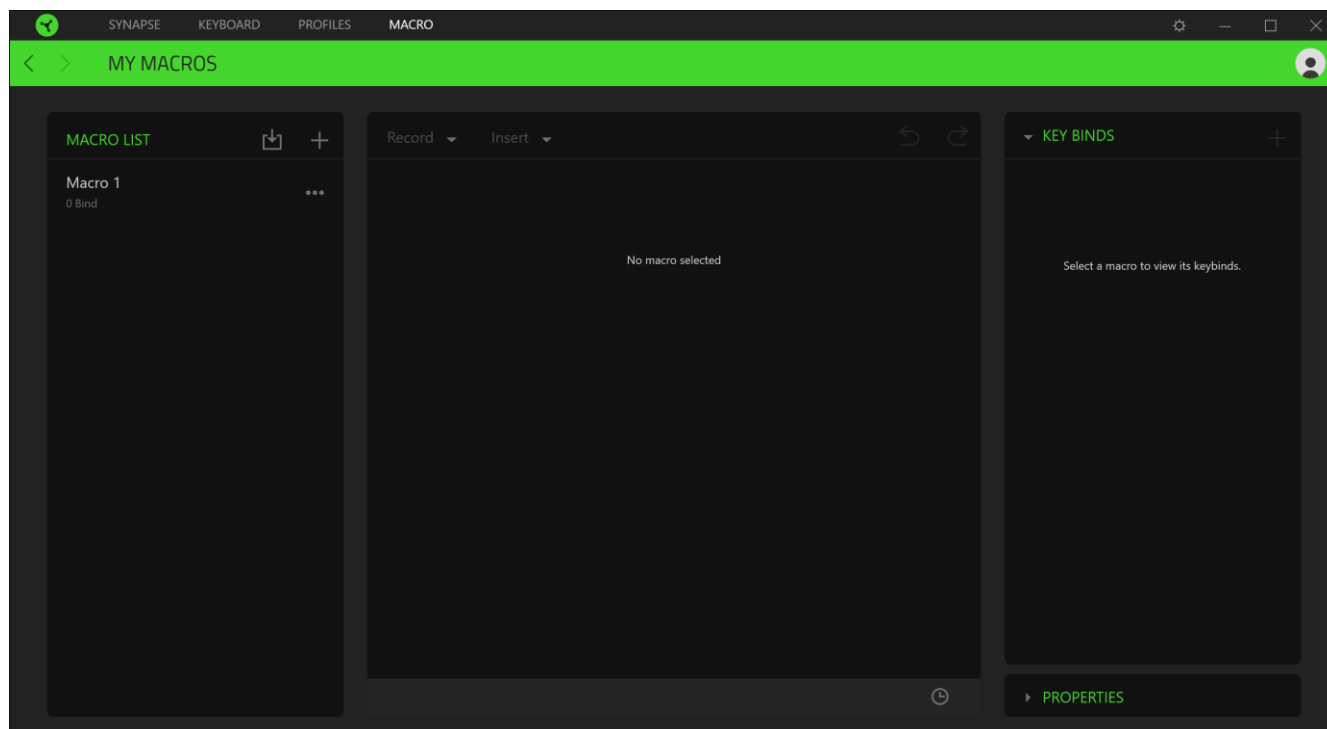
If you need to accurately execute a series of complex commands then you need a Macro. A macro is a set of recorded keystrokes, button presses, and cursor movements. The Macros tab allows you to create, edit, and organize these macros so that you can assign them to the keys or buttons of your Razer device. You can also share macros with others using the import button () and export button ().



There are also other options available in the macro section such as creating a new macro by clicking the Add button (), delete the current macro by clicking the Trash button (), and duplicate the current macro using the Copy button ().

To create a macro, simply select a macro name to store your commands, then click the **Record** menu.

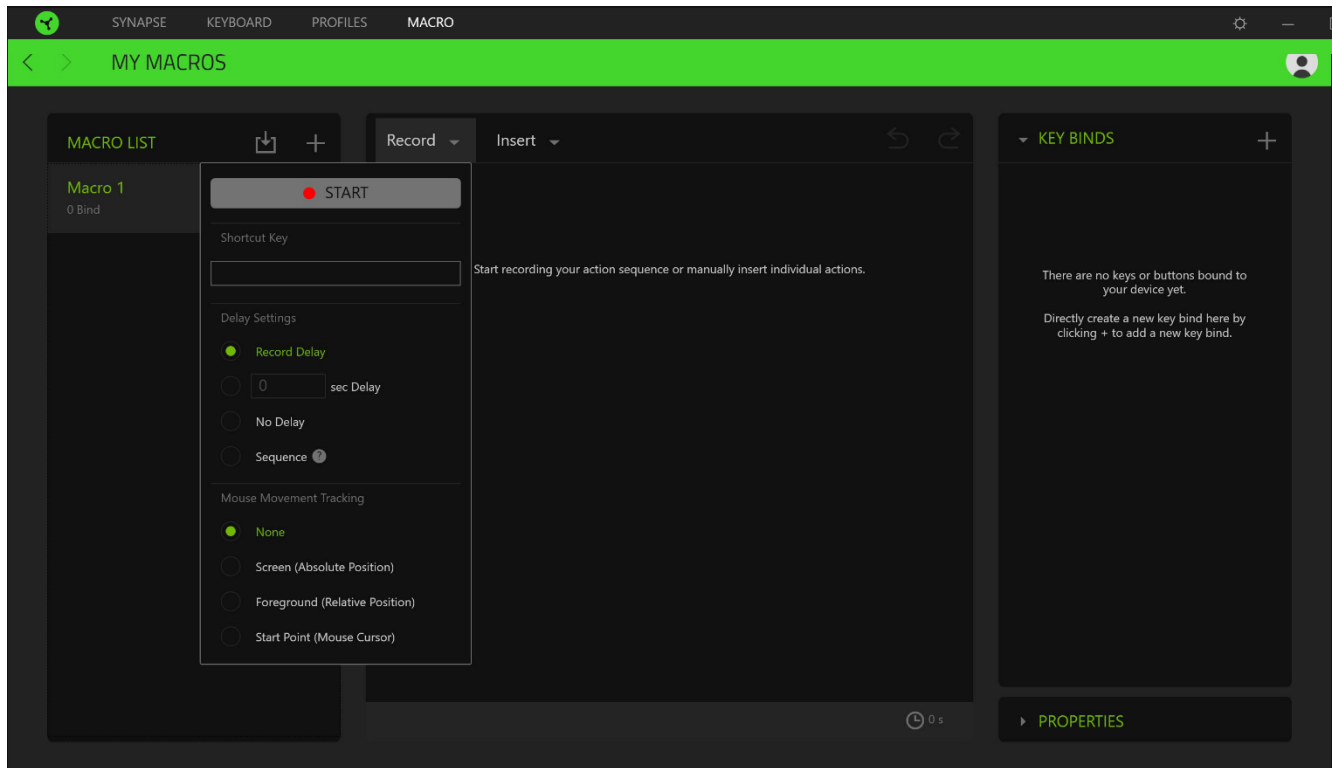



From here you may assign a key or button on the Shortcut Key field that will start or stop the macro recording if you want to record commands and/or movements outside the Razer Synapse 3 window. You may also opt to include or remove the delay or the amount of time between each command through the Delay Settings listed below:

- Record delay – Includes all delays between each command.
- Sec delay – Uses your specified time (in seconds) as a delay between each command.
- No Delay – Removes all delays between each command.
- Sequence– Upon binding a macro using this setting to a button or key, each command within the macro will only be executed by pressing the key bound to the macro continuously.

Or choose to remove or include your preferred mouse movement tracking setting from any of the settings listed below:

- None – Removes all mouse movements made during the macro recording.
- Screen (Absolute Position) – Uses and preserves the exact coordinates of the recorded mouse movement regardless of screen size changes.

- Foreground (Relative Position) – Automatically scales recorded mouse movements proportionally to your screen’s current resolution.
- Start point (Mouse Cursor) – Uses the current position of your mouse cursor when performing mouse patterns within macros.

Once you have chosen the settings for the macro, click the Start button (). After a brief countdown, all keystrokes, button presses, and mouse movements will be recorded on the macro screen. When you are done recording your macro commands, click on the Stop button () or simply press the Shortcut key to end the session.

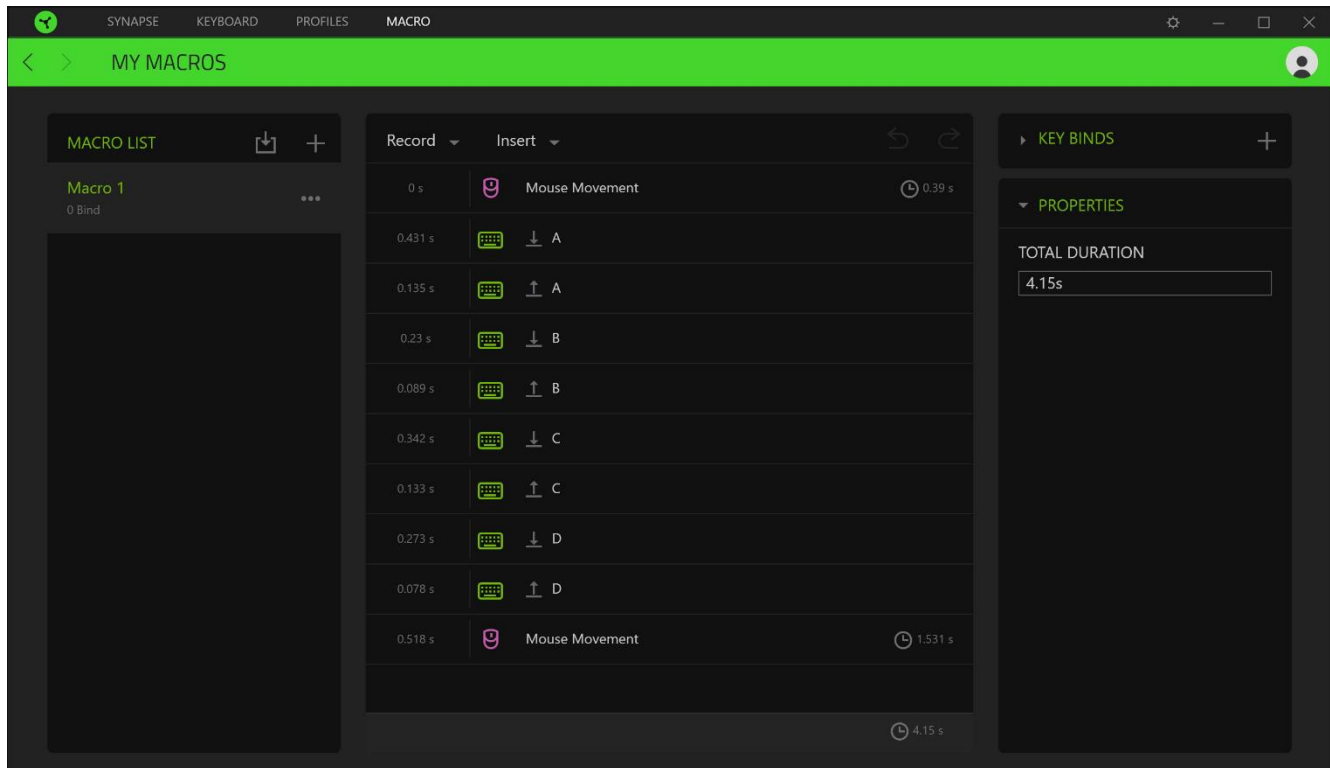

You may then proceed on binding the new macro with your preferred button or key using the Key Binds option. You may also change the overall duration of the recorded macro through the Total Duration field on the Properties option.

Note: Changing the overall duration of a macro will proportionally adjust all delays included each command within the macro.

Once you have recorded a macro, you may edit the commands you have entered by selecting each command on the macro screen. Each keystroke or button press is arranged sequentially with the first command shown at the top of the screen.

The Insert drop-down menu allows you to put in additional keystrokes, button presses, type texts, run commands, loop a set of commands within the macro, or insert an entire macro group within the macro.

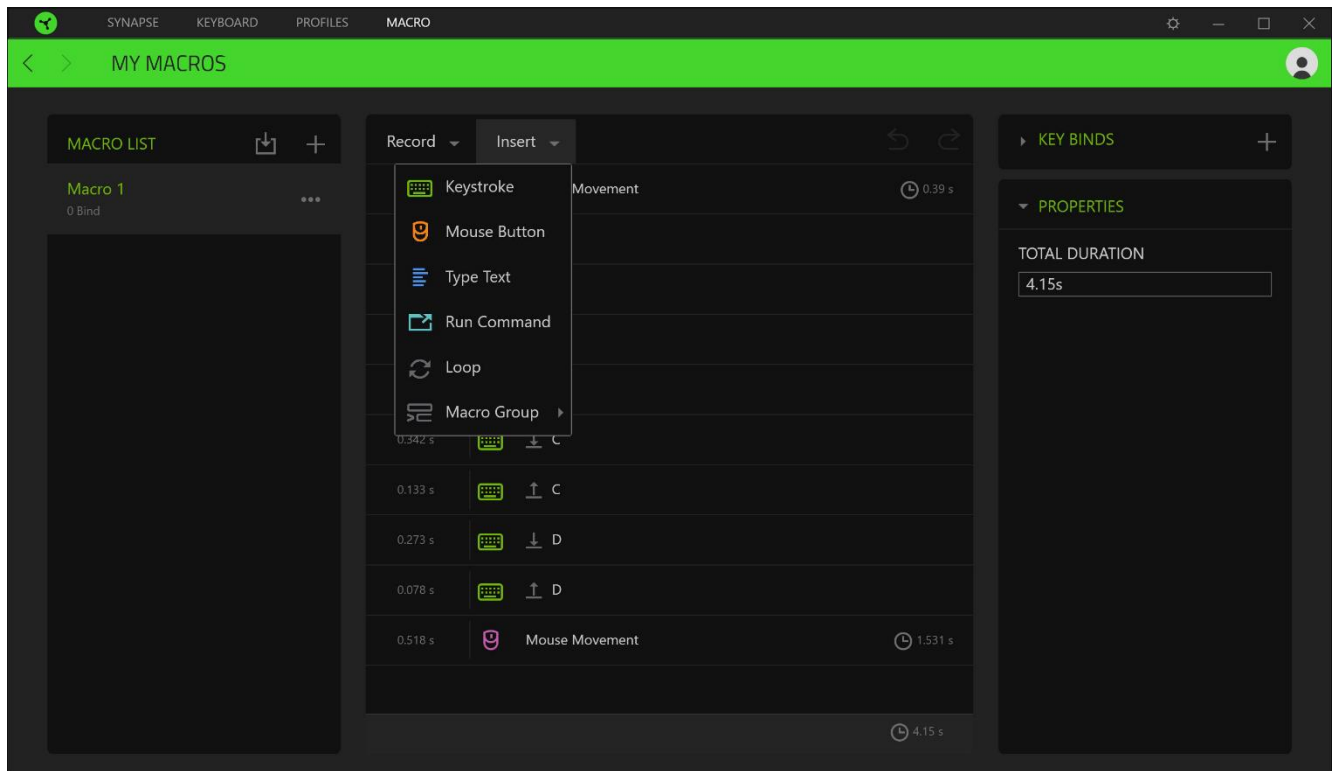

Key Binds

The Key binds option allows you to view the Shortcut Keys for the selected macro. You can bind a macro to the key or button of your choice without leaving the Macro tab by selecting the Macro you want to bind, and then clicking the Key bind button (+).

Properties

The Properties option enables you to individually edit commands, adjust their delay, change actions, and also change the total duration of the macro so that it executes faster or slower.

SETTINGS WINDOW

The Settings window, accessible by clicking the (⚙️) button on Razer Synapse 3, enables you to configure the startup behavior and display language of Razer Synapse 3, view the master guides of each connected Razer device, or perform factory reset on any connected Razer device.

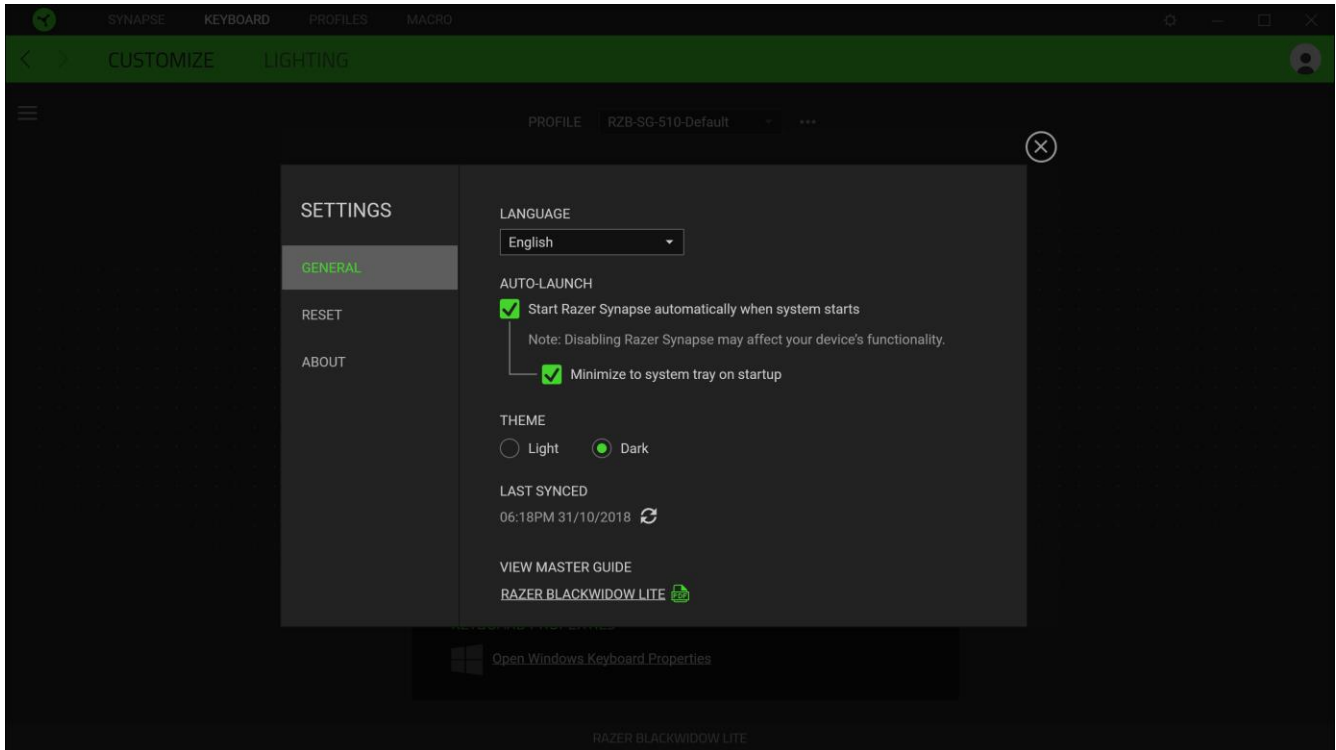

General tab

The default tab of the Settings window. The General tab enables you to change the software's display language, start-up behavior, and display theme. You may also manually sync your profiles to the cloud (↻) or view the master guide of all connected Razer devices.

Reset tab

The Reset tab allows you to perform a factory reset on all connected Razer devices with on-board memory and/or reset Razer Synapse 3 tutorials to acquaint yourself again with Razer Synapse 3's new features on its next launch.

Note: By resetting a Razer device, all profiles stored on the selected device's on-board memory will be erased.

About tab

The About tab displays brief software information and copyright statement, and provides relevant links for its terms of use. You may also use this tab to check for software updates, or as a quick access to Razer's social communities.

8. SAFETY AND MAINTENANCE

SAFETY GUIDELINES

In order to achieve maximum safety while using your Razer BlackWidow Lite, we suggest that you adopt the following guidelines:

Should you have trouble operating the device properly and troubleshooting does not work, unplug the device and contact the Razer hotline or go to support.razer.com for support.

Do not take apart the device (doing so will void your warranty) and do not attempt to operate it under abnormal current loads.

Keep the device away from liquid, humidity or moisture. Operate the device only within the specific temperature range of 0°C (32°F) to 40°C (104°F). Should the temperature exceed this range, unplug and/or switch off the device in order to let the temperature stabilize to an optimal level.

COMFORT

Research has shown that long periods of repetitive motion, improper positioning of your computer peripherals, incorrect body position, and poor habits may be associated with physical discomfort and injury to nerves, tendons, and muscles. Below are some guidelines to avoid injury and ensure optimum comfort while using your Razer BlackWidow Lite.

1. Position your keyboard and monitor directly in front of you with your mouse next to it. Place your elbows next to your side, not too far away and your keyboard within easy reach.
2. Adjust the height of your chair and table so that the keyboard and mouse are at or below elbow height.
3. Keep your feet well supported, posture straight and your shoulders relaxed.
4. During gameplay, relax your wrist and keep it straight. If you do the same tasks with your hands repeatedly, try not to bend, extend or twist your hands for long periods.
5. Do not rest your wrists on hard surfaces for long periods.
6. Use a wrist rest to support your wrist while gaming.
7. Customize the keys on your keyboard to suit your style of gaming in order to minimize repetitive or awkward motions while gaming.
8. Do not sit in the same position all day. Get up, step away from your desk and do exercises to stretch your arms, shoulders, neck and legs.

If you should experience any physical discomfort while using your keyboard, such as pain, numbness, or tingling in your hands, wrists, elbows, shoulders, neck or back, please consult a qualified medical doctor immediately.

MAINTENANCE AND USE

The Razer BlackWidow Lite requires minimum maintenance to keep it in optimum condition. Once a month we recommend you unplug the device from the computer and clean it using a soft cloth or cotton swab to prevent dirt buildup. Do not use soap or harsh cleaning agents.

9. LEGALESE

COPYRIGHT AND INTELLECTUAL PROPERTY INFORMATION

©2019 Razer Inc. All rights reserved. Razer, the triple-headed snake logo, Razer logo, and “For Gamers. By Gamers.”, are trademarks or registered trademarks of Razer Inc. and/or affiliated companies in the United States or other countries. All other trademarks are the property of their respective owners.

Windows and the Windows logo are trademarks of the Microsoft group of companies.

Razer Inc. (“Razer”) may have copyright, trademarks, trade secrets, patents, patent applications, or other intellectual property rights (whether registered or unregistered) concerning the product in this guide. Furnishing of this guide does not give you a license to any such copyright, trademark, patent or other intellectual property right. The Razer BlackWidow Lite (the “Product”) may differ from pictures whether on packaging or otherwise. Razer assumes no responsibility for such differences or for any errors that may appear. Information contained herein is subject to change without notice.

LIMITED PRODUCT WARRANTY

For the latest and current terms of the Limited Product Warranty, please visit [razer.com/warranty](https://www.razer.com/warranty).

LIMITATION OF LIABILITY

Razer shall in no event be liable for any lost profits, loss of information or data, special, incidental, indirect, punitive or consequential or incidental damages, arising in any way out of distribution of, sale of, resale of, use of, or inability to use the Product. In no event shall Razer’s liability exceed the retail purchase price of the Product.

GENERAL

These terms shall be governed by and construed under the laws of the jurisdiction in which the Product was purchased. If any term herein is held to be invalid or unenforceable, then such term (in so far as it is invalid or unenforceable) shall be given no effect and deemed to be excluded without invalidating any of the remaining terms. Razer reserves the right to amend any term at any time without notice.