

# Lenovo G27c-10 User Guide

**Lenovo**<sup>™</sup>

---

## Product Number

66A3-GACB-WW

66A3-GCCB-WW



First Edition (10 2019)

© Copyright Lenovo 2019. All rights reserved.

LENOVO products, data, computer software, and services have been developed exclusively at private expense and are sold to governmental entities as commercial items as defined by 48 C.F.R. 2.101 with limited and restricted rights to use, reproduction and -disclosure. LIMITED AND RESTRICTED RIGHTS NOTICE: IF products, data, computer software, or services are delivered pursuant a -General Services Administration "GSA" contract, use, reproduction, or disclosure is subject to restrictions set forth in Contract No. -GS-35F-05925.

---

# Contents

Product Number .....	i
Contents.....	ii
Safety information.....	iii
<b>Chapter 1 Getting started .....</b>	<b>1-1</b>
Shipping contents .....	1-1
Notice for use .....	1-1
Product overview.....	1-2
Types of adjustments.....	1-2
User controls.....	1-2
Cable lock slot.....	1-3
Setting up your monitor .....	1-3
Connecting and turning on your monitor .....	1-3
Registering your option .....	1-6
<b>Chapter 2 Adjusting and using your monitor .....</b>	<b>2-1</b>
Comfort and accessibility.....	2-1
Arranging your work area.....	2-1
Positioning and viewing your monitor.....	2-1
Quick tips for healthy work habits.....	2-2
Eye Strain .....	2-2
Low Blue Light.....	2-2
Accessibility information .....	2-3
Adjusting your monitor image.....	2-4
Using the direct access controls .....	2-4
Using the On-Screen Display (OSD) controls .....	2-4
Selecting a supported display mode.....	2-6
Understanding power management.....	2-6
Caring for your monitor .....	2-7
Detaching the monitor stand.....	2-7
Wall Mounting (Optional).....	2-7
<b>Chapter 3 Reference information .....</b>	<b>3-1</b>
Monitor specifications .....	3-1
Troubleshooting.....	3-2
Manually installing the monitor driver .....	3-4
Service information .....	3-6
<b>Appendix A Service and Support.....</b>	<b>A-1</b>
Registering your option .....	A-1
Online technical support .....	A-1
Telephone technical support .....	A-1
<b>Appendix B Notices .....</b>	<b>B-1</b>
Recycling information .....	B-1
Collecting and recycling a disused Lenovo computer or monitor.....	B-2
Disposing of Lenovo computer components .....	B-2
Trademarks .....	B-2
Power cords .....	B-3

---

# Safety information

## General Safety guidelines

For tips to help you use your computer safely, go to:  
<http://www.lenovo.com/safety>  
Before installing this product, read the Safety Information.



### **DANGER**

#### **To avoid shock hazard:**

- Do not remove the covers.
- Do not operate this product unless the stand is attached.
- Do not connect or disconnect this product during an electrical storm.
- The power cord plug must be connected to a properly wired and grounded power outlet.
- Any equipment to which this product will be attached must also be connected to properly wired and grounded power outlets.
- To isolate the monitor from the electrical supply, you must remove the plug from the power outlet. The power outlet should be easily accessible.

To take special precautions to avoid the introduction of hazards when operating, installing, servicing, transporting or storing equipment, the necessary instructions shall be made available. To reduce the risk of electric shock, do not perform any servicing other than that contained in the operating instructions unless you are qualified to do so.

#### **Handling:**

- If your monitor weighs more than 18 kg (39.68 lb), it is recommended that it be moved or lifted by two people.



---

# Chapter 1 Getting started

This User's Guide provides detailed operation instructions for the user. For quick instruction overview, please see the Setup Poster for brief information.

---

## Shipping contents

The product package should include the following items:

- Curved Panel Monitor
- Information Flyer
- Monitor Stand
- Monitor base
- Power Cord
- HDMI Cable

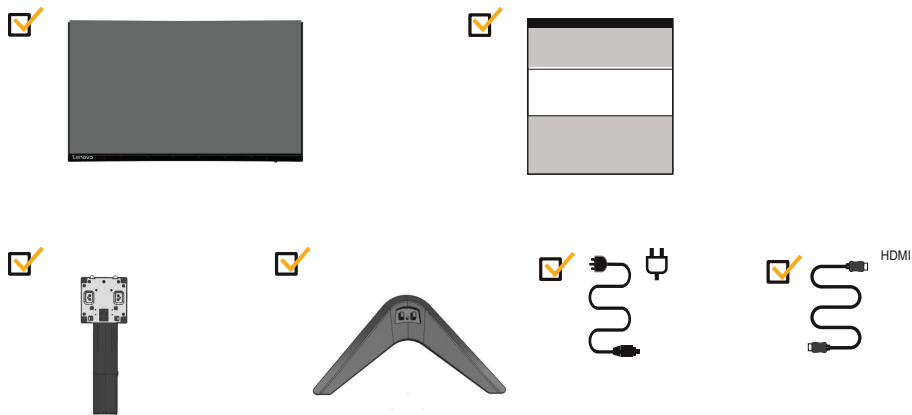

---

## Notice for use

To setup your monitor, please see the illustrations below.

**Note:** Do not touch the monitor within the screen area. The screen area is glass and can be damaged by rough handling or excessive pressure.

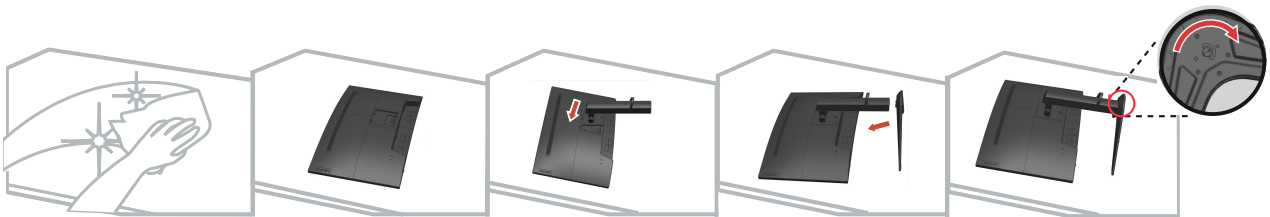

1. Carefully lay the monitor on a flat surface
2. Put the stand and base to the monitor.

**Note:** To attach a VESA mount, please see “Wall Mounting (Optional)” on page 2-7.

---

## Product overview

This section will provide information on adjusting monitor positions, setting user controls, and using the cable lock slot.

### Types of adjustments

#### Tilt

Please see the illustration below for an example of the tilt range.



#### Height Adjustment

For height adjustment, user needs to press down or lift up the monitor.

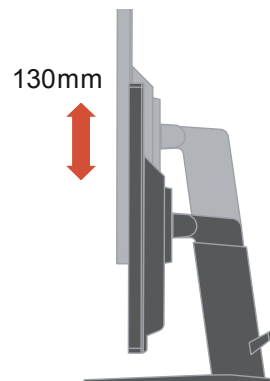

### User controls

Your monitor has controls on the front which are used to adjust the display.

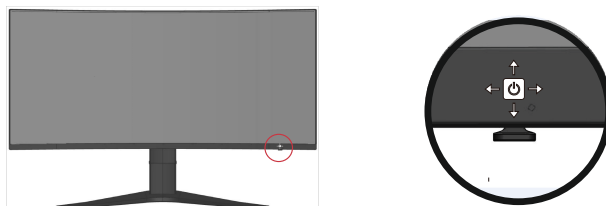

For information on how to use these controls, please see "Adjusting your monitor image" on page 2-3.

## Cable lock slot

Your monitor is equipped with a cable lock slot located on the rear of your monitor. (In the lower left position)

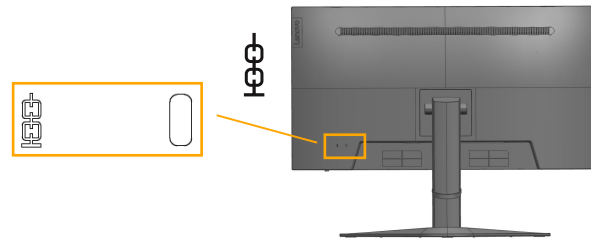

---

## Setting up your monitor

This section provides information to help you set up your monitor.

### Connecting and turning on your monitor

**Note:** Be sure to read the Safety information on page iii before carrying out this procedure.

1. Power off your computer and all attached devices, and unplug the computer power cord.

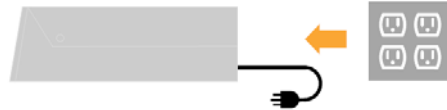

2. Connect the DP cable to the DP connector of the monitor and the other end on the back of the computer.

DP

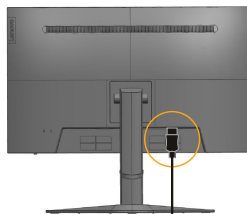

DP

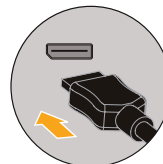
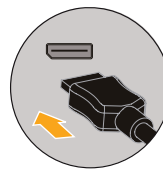

3. Connect one end of the HDMI cable to the HDMI connector on the back of the computer, and the other end to the HDMI connector on the monitor. Lenovo recommends that customers who require to use the HDMI input on their monitor purchase the "Lenovo HDMI to HDMI cableOB47070".

For more information, go to the following:  
[www.lenovo.com/support/monitoraccessories](http://www.lenovo.com/support/monitoraccessories)

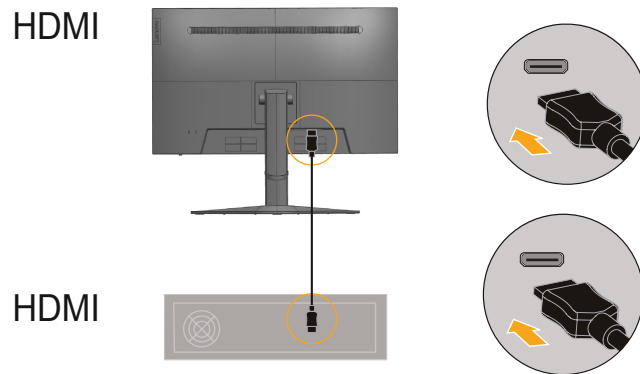

4. Connect the speaker's audio cable and audio jack of monitor to transfer audio source from DP, HDMI.

**Note:** The audio output in DP, HDMI modes.

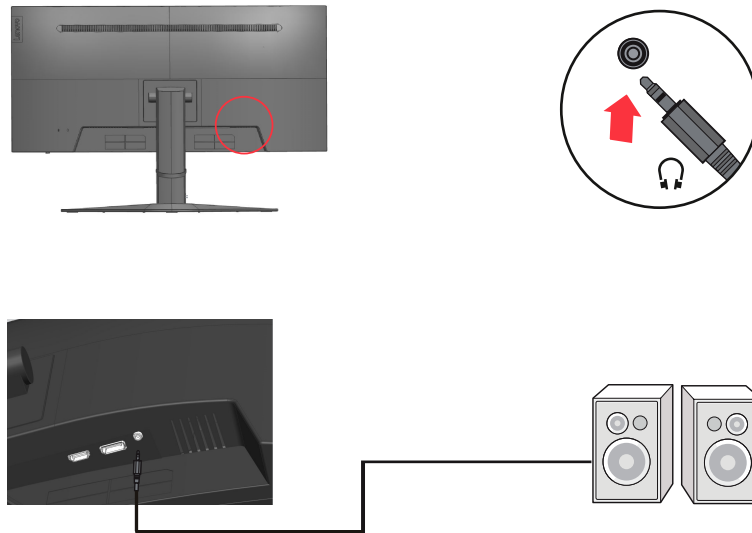

5. Plug the monitor power cord and the computer cord into grounded electrical outlets.

**Note:** A certified power supply cord has to be used with this equipment. The relevant national installation and/or equipment regulations shall be considered. A certified power supply cord not lighter than ordinary polyvinyl chloride flexible cord according to IEC 60227 (designation H05VV-F 3G 0.75mm<sup>2</sup> or H05VVH2-F2 3G 0.75mm<sup>2</sup>) shall be used. Alternative a flexible cord be of synthetic rubber according to IEC 60245 (designation H05RR-F 3G 0.75mm<sup>2</sup>) shall be used.

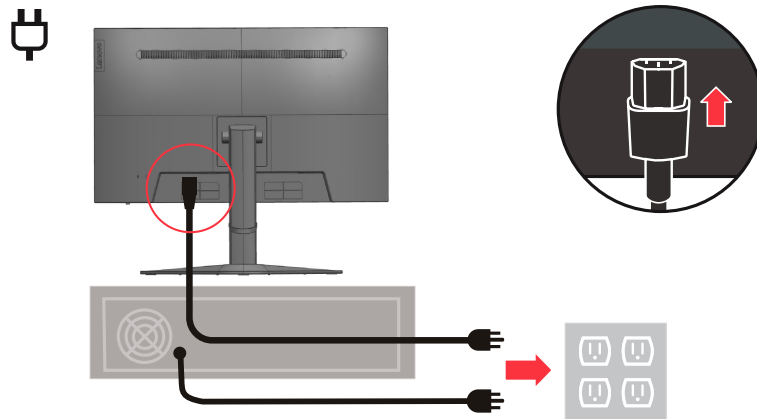

6. Connect the cables with cable clip.

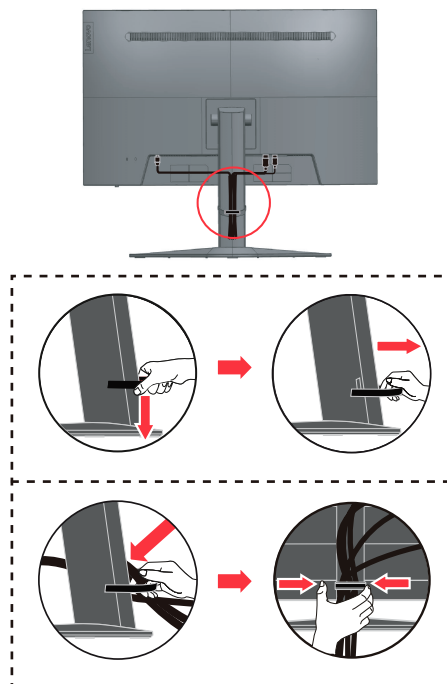

7. Power on the monitor and the computer.

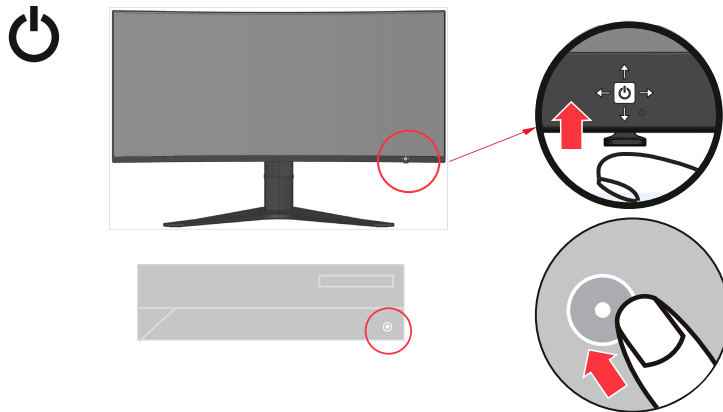

8. To install the monitor driver, you must download it from Lenovo website ([http://pcsupport.lenovo.com/solutions/g27c\\_10](http://pcsupport.lenovo.com/solutions/g27c_10)) and follow the instructions on page 3-4.

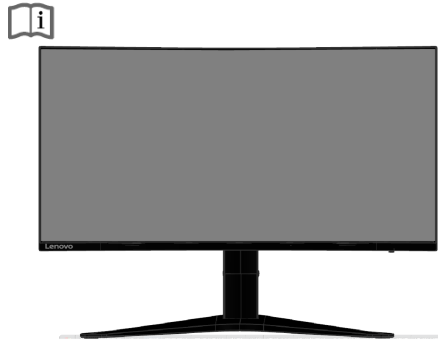

## Registering your option

Thank you for purchasing this Lenovo™ product. Please take a few moments to register your product and provide us with information that will help Lenovo to better serve you in the future. Your feedback is valuable to us in developing products and services that are important to you, as well as in developing better ways to communicate with you. Register your option on the following Web site:

<http://www.lenovo.com/register>

Lenovo will send you information and updates on your registered product unless you indicate on the Web site questionnaire that you do not want to receive further information.

---

## Chapter 2 Adjusting and using your monitor

This section will give you information on adjusting and using your monitor.

---

### Comfort and accessibility

Good ergonomic practice is important to get the most from your personal computer and to avoid discomfort. Arrange your workplace and the equipment you use to suit your individual needs and the kind of work that you perform. In addition, use healthy work habits to maximize your performance and comfort while using your computer.

---

### Arranging your work area

Use a work surface of appropriate height and available working area to allow you to work in comfort.

Organize your work area to match the way you use materials and equipment. Keep your work area clean and clear for the materials that you typically use and place the items that you use most frequently, such as the computer mouse or telephone, within the easiest reach.

Equipment layout and setup play a large role in your working posture. The following topics describe how to optimize equipment setup to achieve and maintain good working posture.

---

### Positioning and viewing your monitor

Position and adjust your computer monitor for comfortable viewing by considering the following items:

- **Viewing distance:**

Optimal viewing distances for monitors range from approximately 510mm to 760mm (20 in to 30 in) and can vary depending on ambient light and time of day. You can achieve different viewing distances by repositioning your monitor or by modifying your posture or chair position. Use a viewing distance that is most comfortable for you.

- **Monitor height:**

Position the monitor so your head and neck are in a comfortable and neutral (vertical, or upright) position. If your monitor does not have height adjustments, you might have to place books or other sturdy objects under the base of the monitor to achieve the desired height. A general guideline is to position the monitor such that the top of the screen is at or slightly below your eye-height when you are comfortably seated. However, be sure to optimize your monitor height so the line of site between your eyes and the center of the monitor suits your preferences for visual distance and comfortable viewing when your eye muscles are in a relaxed state.

- **Tilt :**

Adjust the tilt of your monitor to optimize the appearance of the screen content and to accommodate your preferred head and neck posture.

- **General location:**

Position your monitor to avoid glare or reflections on the screen from overhead lighting or nearby windows.

The following are some other tips for comfortable viewing of your monitor:

- Use adequate lighting for the type of work you are performing.
- Use the monitor brightness, contrast, and image adjustment controls, if equipped, to optimize the image on your screen to meet your visual preferences.
- Keep your monitor screen clean so you can focus on the screen's contents.

Any concentrated and sustained visual activity can be tiring for your eyes. Be sure to periodically look away from your monitor screen and focus on a far object to allow your eye muscles to relax. If you have questions on eye fatigue or visual discomfort, consult a vision care specialist for advice.

---

## Quick tips for healthy work habits

The following information is a summary of some important factors to consider to help you remain comfortable and productive while you use your computer.

- **Good posture starts with equipment setup:**

The layout of your work area and the setup of your computer equipment have a large effect on your posture while using your computer. Be sure to optimize the position and orientation of your equipment by following the tips outlined in “Arranging your work area” on page 2-1 so you can maintain a comfortable and productive posture. Also, be sure to use the adjustment capabilities of your computer components and office furniture to best suit your preferences now and as your preferences change over time.

- **Minor changes in posture can help avoid discomfort:**

The longer you sit and work in front of your computer, the more important it is to observe your working posture. Avoid assuming any one posture for an extended period of time. Periodically make minor modifications in your posture to help deter any discomforts that might arise. Make use of any adjustments that your office furniture or equipment provide to accommodate changes in posture.

- **Short, periodic breaks help ensure healthy computing:**

Because computing is primarily a static activity, it is particularly important to take short breaks from your work. Periodically, stand up in front of your work area, stretch, walk for a drink of water, or otherwise take a short break from using your computer. A short break from work gives your body a welcome change in posture and helps to ensure you remain comfortable and productive while you do work.

---

## Eye Strain

- **Break Times**

Computer users should take some time away from the screen especially if working for prolonged hours. Generally, it is recommended to take short breaks (5 – 15 min.) after 1 – 2 hours of continuous computer work. Taking short and frequent breaks is more advised than longer breaks.

- **Looking at Distant Objects**

Users often blink less when in front of monitor screen. To minimize eye strain and dryness, users should rest the eye periodically by focusing on objects that are far away.

- **Eye Exercises**

1. Alternate looking up and looking down while keeping the body and head upright.
2. Slowly roll your eyes to look to the left and right.
3. Roll eyes to look at objects on the upper right corner and then on lower right. Do same thing to look at objects on the upper left and lower left.

---

## Low Blue Light

Concerns on blue light affecting eye health have risen over the years. Blue light has a wavelength between 300 nm to 500 nm. The monitors have a factory setting that reduces blue light emissions. Users can enable low blue light mode on these monitors from the OSD settings.

1. Press → to open the main OSD menu.

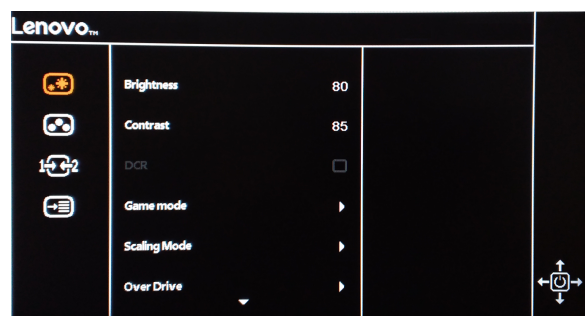



2. Use **↑** or **↓** to move among the icons. Select icon  and press **→** to access this function.

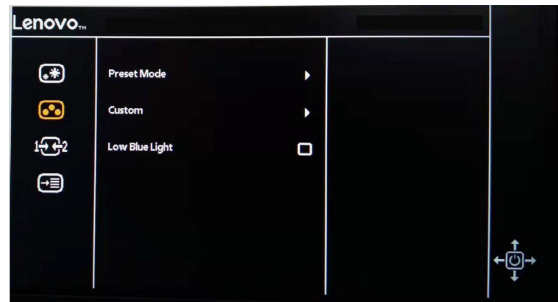

3. Use **↑** or **↓** to move among the functions. Select Low Blue Light to access this function.

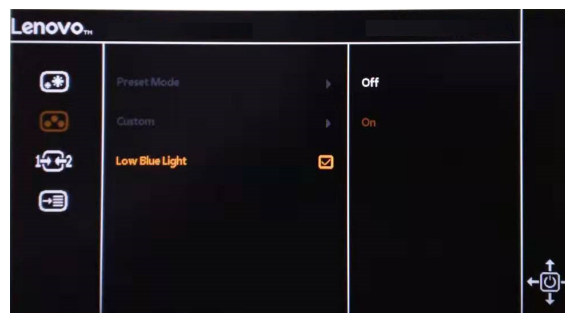

4. Use **↑** or **↓** to move among the icons. Select icon **On** and press **→** to access this function.

---

## Accessibility information

Lenovo is committed to providing greater access to information and technology to people with disabilities. With assistive technologies, users can access information in the way most appropriate to their disability. Some of these technologies are already provided in your operating system; others can be purchased through vendors or accessed at:

[https://lenovo.ssbartgroup.com/lenovo/request\\_vpat.php](https://lenovo.ssbartgroup.com/lenovo/request_vpat.php)

# Adjusting your monitor image

This section describes the user control features used to adjust your monitor image.

## Using the direct access controls

The direct access controls can be used when the On Screen Display (OSD) is not displayed.

Table 2-1. Direct access controls

Icon	Control	Description
←	Input change DDC-CI	Switches the video input source. Press and hold for 10 seconds to enable or disable the DDC-CI function
→	Main menu	Open OSD main menu Press and hold for 10 seconds will lock menu/unlock menu
↑	NO function	
↓	Brightness Low Blue Light	Direct access to Brightness adjustment. Press and hold for 3 seconds will enable or disable the Low Blue Light

## Using the On-Screen Display (OSD) controls



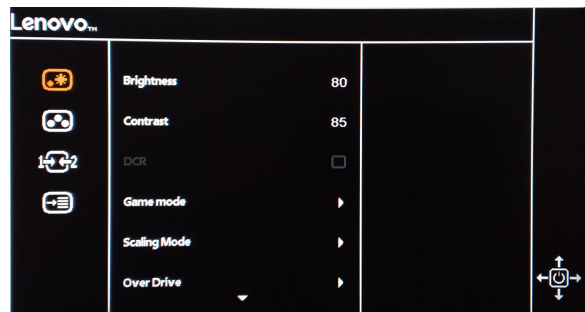

The settings adjustable with the user controls are viewed through the On-Screen Display (OSD), as shown below.



To use the controls:

1. Press → to open the main OSD menu.
2. Use ↑ or ↓ to move among the icons. Select an icon and press → to access that function. If there is a sub-menu, you can move between options using ↑ or ↓, then press → to select that function. Use ↑ or ↓ to make adjustments. Press → to save.
3. Press ← to move backwards through the sub-menus and exit from the OSD.
4. Press and hold → for 10 seconds to lock the OSD. This will prevent accidental adjustments to the OSD. Press and hold → for 10 seconds to unlock the OSD and allow adjustments to the OSD.
5. Enables DDC/CI by default. Use OSD Exit Key, press and hold the ← buttons for 10 seconds to disable/enable DDC/CI function. The words " DDC/CI Disable/DDC/CI/Enable" shows on the screen.

Table 2-2. OSD functions

OSD Icon on Main Menu	Sub menu	Description	Controls and Adjustments	
 <b>Basic image setting</b>	Brightness	Adjust bar	All input ports	
	Contrast	Adjust bar		
	DCR	Off / On		
	Game Mode	Standard		
		FPS1		
		FPS2		
		Racing		
		RTS		
		Game1		
	Scaling Mode	Game2		
		Full Screen		
	Over Drive	Original AR		
		Off		
Normal				
FreeSync	Extreme			
	Off / On			
MPRT	Off / On			
Saturation	Adjust bar			
Dark boost	Off/Level1/Level2/Level3			
 <b>Image color setting</b>	Preset Mode	Bluish	All input ports	
		Neutral		
		Reddish		
		sRGB		
	Custom	Red		Adjust bar
		Green		Adjust bar
		Blue		Adjust bar
Low Blue Light	Off			
	On			
 <b>signal input</b>	HDMI			
	DP			
 <b>Menu setting</b>	Information	Model name: Refresh: Firmware: Serial Number :	All input ports	
	Language	English		
		French (Français)		
		Italian (Italiano)		
		简体中文		
		Spanish (Español)		
		Japanese (日本語)		
		German (Deutsch)		
	Russian (Русский)			
	Menu Horizontal	Adjust bar		
	Menu Vertical	Adjust bar		
	Refresh Rate	Off/Left Top/Right Top/Left Bottom/Right Bottom		
	Transparency	Off		
		20		
40				
60				
80				
DP Select	100			
	DP 1.1			
OSD Timeout	DP 1.2			
	Adjust bar (5-60)			
Reset All Settings	Cancel			
	Factory Reset			

---

## Selecting a supported display mode

The display mode the monitor uses is controlled by the computer. Therefore, refer to your computer documentation for details on how to change display modes.

The image size, position and shape might change when the display mode changes. This is normal and the image can be readjusted using automatic image setup and the image controls.

Unlike CRT monitors, which require a high refresh rate to minimize flicker, LCD or Curved Panel technology is inherently flicker-free.

**Note:** If your system has previously been used with a CRT monitor and is currently configured to a display mode outside the range of this monitor, you may need to re-attach the CRT monitor temporarily until you have re-configured the system; preferably to 1920x1080 at 165Hz, which is the Native Resolution Display mode.

The display modes shown below have been optimized at the factory.

*Table 2-3. Factory set display modes*

Addressability	Refresh rate
640x480	60Hz, 72Hz, 75Hz
720x400	70Hz
800x600	56Hz, 60Hz, 72Hz, 75Hz
832x624	75Hz
1024x768	60Hz, 70Hz
1152x864	75Hz
1280x720	60Hz
1280x1024	60Hz, 70Hz, 75Hz
1366x768	60Hz
1680x1050	60Hz
1600x900	60Hz
1920x1080	60Hz, 75Hz, 120Hz, 144Hz, 165Hz

---

## Understanding power management

Power management is invoked when the computer recognizes that you have not using your mouse or keyboard for a user-definable period. There are several states as described in the table below.

For optimal performance, switch off your monitor at the end of each working day, or whenever you expect to leave it unused for long periods during the day.

*Table 2-4. Power indicator*

State	Power Indicator	Screen	Restoring Operation	Compliance
On	Steady White	Normal		
Standby/ Suspend	Steady amber	Blank	Press a key or move the mouse. There may be a slight delay reappears. Note: Standby also occurs if there is no image output to the monitor.	
Off	Off	Off	Press power key to switch on There may be a slight delay before the image reappears.	

---

## Caring for your monitor

Be sure to turn off the power before you perform any maintenance on the monitor.

### Do not:

- Apply water or liquid directly to your monitor.
- Use solvents or abrasives.
- Use flammable cleaning materials to clean your monitor or any other electrical equipment.
- Touch the screen area of your monitor with sharp or abrasive items. This type of contact may cause permanent damage to your screen.
- Use any cleaner which contains an anti-static solution or similar additives. This may harm the coating of the screen area.

### Do:

- Lightly dampen a soft cloth with water and use this to gently wipe the covers and the screen.
- Remove grease or finger marks with a damp cloth and a little mild detergent.

---

## Detaching the monitor stand

After placing the monitor face down on a clean surface or soft cloth, Press the release button to remove the stand and base from the monitor.



---

## Wall Mounting (Optional)

Refer to the instructions that come with the base mounting kit. To convert your LCD display from a desk-mounted to a wall-mounted display, do the following:

Step 1: Verify that the Power button is turned Off, then disconnect the power cord.

Step 2: Lay the LCD display face down on a towel or blanket.

Step 3: Remove the base from the monitor, refer to “Detaching the monitor base and stand”.

Step 4: Attach the mounting bracket from the VESA compatible wall mounting kit (100mm x100mm distance), VESA Mounting Screw M4 x 10 mm.

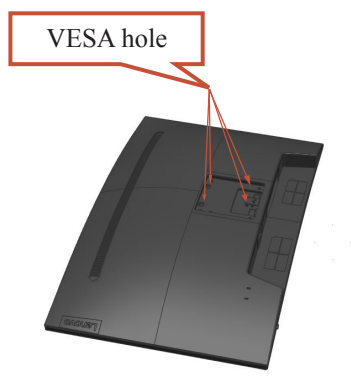

Step 5: Attach the LCD display to the wall, following the instructions in the wallmounting kit.

For use only with UL/GS Listed Wall Mount Bracket with minimum weight/load: 8kg

## Chapter 3 Reference information

This section contains monitor specifications, instructions to manually install the monitor driver, troubleshooting information, and service information.

### Monitor specifications

Table 3-1. Monitor specifications

Dimensions	Height Depth Width	390.4~520.4mm (15.37~20.49 in.) 234.8mm (9.24 in.) 611.99 mm (24.09 in.)
Stand	Tilt range	Range: -5°/+22°
VESA mount	Supported (UL&GS approved)	100 mm (3.94 in.)
Image	Viewable image size Maximum height Maximum width Pixel pitch	685.98 mm (27 in.) 336.31 mm (13.24 in.) 597.88 mm (23.54 in.) 0.3114mm(H)x0.3114 mm (V)
Power input	Supply voltage Max supply current	90-264 VAC, 47~63 Hz 1.2 A
Power consumption Note: Power consumption figures are for the monitor and the power supply combined.	Max Consumption Typical Consumption Standby/Suspend Off	<33W <27W <0.5W <0.3W
Video input (Digital)	Input signal Horizontal addressability Vertical addressability Clock frequency	DP 1920 pixels (max) 1080 lines (max) 21.6Gbps
Video input (Digital)	Input signal Horizontal addressability Vertical addressability Clock frequency	HDMI 1920 pixels (max) 1080 lines (max) 600 MHz
Communications	VESA DDC	CI
Altitude Test	Operation	16400 ft.
Supported Display Modes (VESA Standard modes between noted ranges)	Horizontal frequency Vertical frequency Native Resolution	30 kHz - 168kHz 48 Hz - 165 Hz 1920x1080 at 165Hz
Temperature	Operating Storage Shipping	0° to 40°C (32°F to 104° F) -20° to 60°C (-4°F to 140° F) -20° to 60°C (-4° F to 140° F)
Humidity	Operating Storage Shipping	10% to 80% 5% to 95% 5% to 95%

# Troubleshooting

If you have a problem setting up or using your monitor, you might be able to solve it yourself. Before calling your dealer or Lenovo, try the suggested actions that are appropriate to your problem.

*Table3-2. Troubleshooting*

<b>Problem</b>	<b>Possible cause</b>	<b>Suggested action</b>	<b>Reference</b>
The words “Out of Range” are shown on the screen, and the power indicator is flashing white.	The system is set to a display mode which is not supported by the monitor.	<p>If you are replacing an old monitor, reconnect it and adjust the display mode to within the specified range for your new monitor.</p> <p>If using a Windows system, restart the system in safe mode, then select a supported display mode for your computer.</p> <p>If these options do not work, contact the Support Center.</p>	“Selecting a supported display mode”on page 2-8
The image quality is unacceptable.	The video signal cable is not connected with the monitor or system completely.	Be sure the signal cable is firmly plugged into the system and monitor.	“Connecting and turning on your monitor”on page 1-3
	The color settings may be incorrect.	Select another color setting from the OSD menu.	“Adjusting your monitor image”on page 2-4
The power indicator is not lit and there is no image.	<ul style="list-style-type: none"> <li>• The monitor’s power switch is not switched on.</li> <li>• The power cord is loose or disconnected.</li> <li>• There is no power at the outlet.</li> </ul>	<ul style="list-style-type: none"> <li>• Be sure the power cord is connected properly.</li> <li>• Be sure the outlet has power.</li> <li>• Power on the monitor.</li> <li>• Try using another power cord.</li> <li>• Try using another electrical outlet.</li> </ul>	“Connecting and turning on your monitor”on page 1-3
Screen is blank and power indicator is amber.	The monitor is in Standby / Suspend mode.	<ul style="list-style-type: none"> <li>• Press any key on the keyboard or move the mouse to restore operation.</li> <li>• Check the Power Options settings on your computer.</li> </ul>	“Understanding power management”on page 2-6
The power indicator is amber, but there is no image.	The video signal cable is loose or disconnected from the system or monitor.	Be sure the video cable is connected with the system properly.	“Connecting and turning on your monitor”on page 1-3
	The monitor brightness and contrast are at the lowest setting.	Adjust the brightness and contrast setting on the OSD menu.	“Adjusting your monitor image”on page 2-4

Table3-2. Troubleshooting (continued)

Problem	Possible cause	Suggested action	Reference
One or more of the pixels appear discolored.	This is a characteristic of the LCD technology and is not an LCD defect.	If there are more than five pixels missing, contact the Support Center.	Appendix A. "Service and Support" on page A-1
<ul style="list-style-type: none"> <li>• Fuzzy lines in text or a blurry image.</li> <li>• Horizontal or vertical lines through the image.</li> </ul>	<ul style="list-style-type: none"> <li>• Image setup has not been optimized.</li> <li>• Your system Display Properties setting have not been optimized.</li> </ul>	Adjust the resolution settings on your system to match the native resolution for this monitor: 1920 x 1080 at 165 Hz.	"Adjusting your monitor image" on page 2-4
		Perform automatic image setup. If automatic image setup does not help, perform manual image setup.	"Selecting a supported display mode" on page 2-6
		When working in the native resolution, you may find additional improvements by adjusting the Dots Per Inch (DPI) setting on your system.	See the Advanced section of your system's display properties.



---

## Manually installing the monitor driver

Below are steps for manually installing the monitor driver in Microsoft Windows 7, Microsoft Windows 10.

### Installing the monitor driver in Windows 7

To install the device driver in Microsoft® Windows 10, do the following:

1. Turn off the computer and all attached devices.
2. Ensure that the monitor is connected correctly.
3. Turn on the monitor and then turn on the computer. Allow your computer to boot into Windows 7 operating system.
4. From the Lenovo website [http://pcsupport.lenovo.com/solutions/g27c\\_10](http://pcsupport.lenovo.com/solutions/g27c_10), find the corresponding monitor driver and download it to a PC to which this monitor is connected (such as a desktop).
5. Open the Display Properties window by right-clicking Start, Control Panel, Hardware and Sound icon, and then click the Display icon.
6. Click the Change the display settings tab.
7. Click the **Advanced Settings** icon.
8. Click the **Monitor** tab.
9. Click the **Properties** button.
10. Click the **Driver** tab.
11. Click **Update Driver**, then click Browse the computer to find the driver program.
12. Select **Pick from the list of device driver program** on the computer.
13. Click the Have Disk button. By clicking the Browse button, browse and point to the following path: X:\Monitor Drivers  
(Where X indicates "the folder in which the downloaded driver is located" (such as a desktop))
14. Select the "G27c-10.inf" file and click the Open button. Click the OK button.
15. Select **Lenovo G27c-10** and click **Next**.
16. After the installation is complete, delete all downloaded files and close all windows.
17. Restart the system. The system will automatically select the maximum refresh rate and corresponding Colour Matching Profiles.

**Note:** On LCD monitors, unlike CRTs, a faster refresh rate does not improve display quality. Lenovo recommends using either 1920x 1080 at a refresh rate of 165 Hz, or 640 x 480 at refresh rate of 60 Hz.

## Installing the monitor driver in Windows 10

To use the Plug and Play feature in Microsoft Windows 10, do the following:

1. Turn off the computer and all attached devices.
2. Ensure that the monitor is connected correctly.
3. Turn on the monitor and then turn on the computer. Allow your computer to boot into Windows 10 operating system.
4. From the Lenovo website [http://pcsupport.lenovo.com/solutions/g27c\\_10](http://pcsupport.lenovo.com/solutions/g27c_10), find the corresponding monitor driver and download it to a PC to which this monitor is connected (such as a desktop).
5. On the Desktop, move mouse to bottom-left corner of screen, right-click choose Control Panel, then double click the icon of Hardware and Sound, and then click Display.
6. Click the Change the display settings tab.
7. Click the **Advanced Settings** button.
8. Click the **Monitor** tab.
9. Click the **Properties** button.
10. Click the **Driver** tab.
11. Click Update Driver, then click Browse the computer to find the driver program.
12. Select **"Let me pick from a list of device drivers on my computer"**.
13. Click the Have Disk button. By clicking the Browse button, browse and point to the following path:  
X:\Monitor Drivers\Windows 10  
(Where X indicates "the folder in which the downloaded driver is located"  
(such as a desktop)
14. Select the **"G27c-10.inf"** file and click the **Open** button. Click the **OK** button.
15. In the new window, select **Lenovo G27c-10** and click Next.
16. After the installation is complete, delete all downloaded files and close all windows.
17. Restart the system. The system will automatically select the maximum refresh rate and corresponding Color Matching Profiles.

Note: On LCD monitors, unlike CRTs, a faster refresh rate does not improve display quality. Lenovo recommends using either 1920x1080 at a refresh rate of 165 Hz, or 640 x 480 at a refresh rate of 60 Hz.

## Service information

### Customer responsibilities

The warranty does not apply to a product which has been damaged due to accident, misuse, abuse, improper installation, usage not in accordance with product specifications and instructions, natural or personal disaster, or unauthorized alterations, repairs or modifications.

The following are examples of misuse or abuse and not covered by warranty:

- Images burned on to the screen of a CRT monitor. Burned image is preventable by utilizing a moving screen saver or power management.
- Physical damage to covers, bezel, base and cables.
- Scratches or punctures on monitor screens.

### Getting further help

If you still can't solve your problem, please contact the Customer Support Center. For more information on contacting the Customer Support Center, please see Appendix A, "Service and Support," on page A-1.

---

## Appendix A Service and Support

The following information describes the technical support that is available for your product, during the warranty period or throughout the life of your product. Refer to the Lenovo Limited Warranty for a full explanation of Lenovo warranty terms.

---

### Registering your option

Register to receive product service and support updates, as well as free and discounted computer accessories and content. Go to: <http://www.lenovo.com/register>

---

### Online technical support

Online technical support is available during the lifetime of a product at:

<http://pcsupport.lenovo.com/solutions>

Product replacement assistance or exchange of defective components also is available during the warranty period. In addition, if your option is installed in a Lenovo computer, you might be entitled to service at your location. A Lenovo technical support representative can help you determine the best alternative.

---

### Telephone technical support

Installation and configuration support through the Customer Support Center will be available until 90 days after the option has been withdrawn from marketing. After that time, the support is cancelled, or made available for a fee, at Lenovo's discretion. Additional support is also available for a nominal fee.

Before contacting a Lenovo technical support representative, please have the following information available: option name and number, proof of purchase, computer manufacturer, model, serial number and manual, the exact wording of any error message, description of the problem, and the hardware and software configuration information for your system.

Your technical support representative might want to walk you through the problem while you are at your computer during the call.

Telephone numbers are subject to change without notice. The most up-to-date telephone list for Lenovo Support is always available at:

<http://pcsupport.lenovo.com/solutions>

Country or Region	Telephone Number
China	400-990-8888
South Africa	800982393
Argentina	0800-222-0279, 541152357144
Australia	1300-557-073
Austria	800295730 (German)
Belgium	80076524 (French, Dutch)
Bolivia	800-101-897

---

## Appendix B Notices

Lenovo may not offer the products, services, or features discussed in this document in all countries. Consult your local Lenovo representative for information on the products and services currently available in your area. Any reference to a Lenovo product, program, or service is not intended to state or imply that only that Lenovo product, program, or service may be used. Any functionally equivalent product, program, or service that does not infringe any Lenovo intellectual property right may be used instead.

However, it is the user's responsibility to evaluate and verify the operation of any other product, program, or service.

Lenovo may have patents or pending patent applications covering subject matter described in this document. The furnishing of this document does not give you any license to these patents. You can send license inquiries, in writing, to:

*Lenovo (United States), Inc.  
1009 Think Place - Building One Morrisville, NC 27560  
U.S.A.  
Attention: Lenovo Director of Licensing*

LENOVO PROVIDES THIS PUBLICATION "AS IS" WITHOUT WARRANTY OF ANY KIND, EITHER EXPRESS OR IMPLIED, INCLUDING, BUT NOT LIMITED TO, THE IMPLIED WARRANTIES OF NON-INFRINGEMENT, MERCHANTABILITY OR FITNESS FOR A PARTICULAR PURPOSE. Some jurisdictions do not allow disclaimer of express or implied warranties in certain transactions, therefore, this statement may not apply to you.

This information could include technical inaccuracies or typographical errors. Changes are periodically made to the information herein; these changes will be incorporated in new editions of the publication. Lenovo may make improvements and/or changes in the product(s) and/or the program(s) described in this publication at any time without notice.

The products described in this document are not intended for use in implantation or other life support applications where malfunction may result in injury or death to persons. The information contained in this document does not affect or change Lenovo product specifications or warranties. Nothing in this document shall operate as an express or implied license or indemnity under the intellectual property rights of Lenovo or third parties. All information contained in this document was obtained in specific environments and is presented as an illustration. The result obtained in other operating environments may vary.

Lenovo may use or distribute any of the information you supply in any way it believes appropriate without incurring any obligation to you.

Any references in this publication to non-Lenovo Web sites are provided for convenience only and do not in any manner serve as an endorsement of those Web sites. The materials at those Web sites are not part of the materials for this Lenovo product, and use of those Web sites is at your own risk.

Any performance data contained herein was determined in a controlled environment. Therefore, the result obtained in other operating environments may vary significantly. Some measurements may have been made on development-level systems and there is no guarantee that these measurements will be the same on generally available systems. Furthermore, some measurements may have been estimated through extrapolation. Actual results may vary. Users of this document should verify the applicable data for their specific environment.

---

## Recycling information

Lenovo encourages owners of information technology (IT) equipment to responsibly recycle their equipment when it is no longer needed. Lenovo offers a variety of programs and services to assist equipment owners in recycling their IT products. For information on recycling Lenovo products, go to:

<http://www.lenovo.com/lenovo/environment/recycling>

環境配慮に関して

本機器またはモニターの回収リサイクルについて

企業のお客様が、本機器が使用済みとなり廃棄される場合は、資源有効利用促進法の規定により、産業廃棄物として、地域を管轄する県知事あるいは、政令市長の許可を持った産業廃棄物処理業者に適正処理を委託する必要があります。また、弊社では資源有効利用促進法に基づき使用済みパソコンの回収および再利用・再資源化を行う「PC回収リサイクル・サービス」を提供しています。詳細は、<http://www.ibm.com/jp/pc/service/recycle/pcrecycle/> をご参照ください。

また、同法により、家庭で使用済みとなったパソコンのメーカー等による回収再資源化が2003年10月1日よりスタートしました。詳細は、<http://www.ibm.com/jp/pc/service/recycle/pcrecycle/> をご参照ください。

重金属を含む内部部品の廃棄処理について

本機器のプリント基板等には微量の重金属（鉛など）が使用されています。使用後は適切な処理を行うため、上記「本機器またはモニターの回収リサイクルについて」に従って廃棄してください。

## Collecting and recycling a disused Lenovo computer or monitor

If you are a company employee and need to dispose of a Lenovo computer or monitor that is the property of the company, you must do so in accordance with the Law for Promotion of Effective Utilization of Resources. Computers and monitors are categorized as industrial waste and should be properly disposed of by an industrial waste disposal contractor certified by a local government. In accordance with the Law for Promotion of Effective Utilization of Resources, Lenovo Japan provides, through its PC Collecting and Recycling Services, for the collecting, reuse, and recycling of disused computers and monitors. For details, visit the Lenovo Web site at [www.ibm.com/jp/pc/service/recycle/pcrecycle/](http://www.ibm.com/jp/pc/service/recycle/pcrecycle/). Pursuant to the Law for Promotion of Effective Utilization of Resources, the collecting and recycling of home-used computers and monitors by the manufacturer was begun in October 1, 2003. This service is provided free of charge for home-used computers sold after October 1, 2003. For details, visit the Lenovo Web site at: [www.ibm.com/jp/pc/service/recycle/personal/](http://www.ibm.com/jp/pc/service/recycle/personal/).

## Disposing of Lenovo computer components

Some Lenovo computer products sold in Japan may have components that contain heavy metals or other environmental sensitive substances. To properly dispose of disused components, such as a printed circuit board or drive, use the methods described above for collecting and recycling a disused computer or monitor.

---

## Trademarks

The following terms are trademarks of Lenovo in the United States, other countries, or both:

Lenovo  
The Lenovo logo  
ThinkCenter  
ThinkPad  
ThinkVision

Microsoft, Windows, and Windows NT are trademarks of the Microsoft group of companies.

Other company, product, or service names may be trademarks or service marks of others.

---

**Power cords**

Use only the power cords supplied by the product manufacture Do not use the ac power cord for other devices.